

VC-TR61

Auto Tracking Camera

User Manual - English

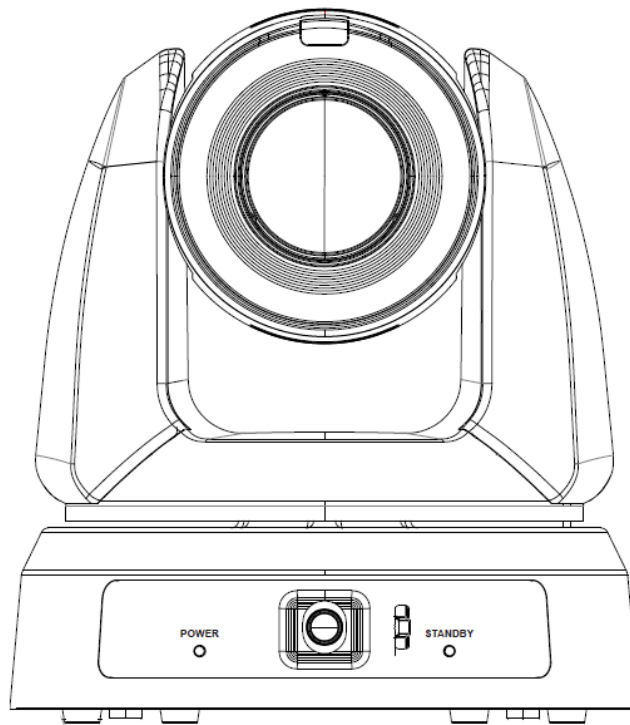

Version VYW100Q

To download the latest version of Quick Start Guide,
multilingual user manual, software, or driver, etc.,
please visit Lumens

<https://www.MyLumens.com/support>

Contents

Chapter 1 Packing List.....	2
Chapter 2 Product Appearance.....	3
2.1 I/O interface	3
2.2 LED Indicator.....	4
2.3 Tally Lamp.....	4
Chapter 3 Installation Instructions	5
3.1 Scenario.....	5
3.2 Instruction for installation	5
3.3 Connection	8
Chapter 4 Remote Control and Setting Menu	9
4.1 Remote control	9
4.2 Setting Menu	10
Chapter 5 Network setting and Web interface.....	15
5.1 Connecting Camera to Network	15
5.2 Web interface functions	17
Chapter 6 Troubleshooting	32
Chapter 7 Addendum.....	33
Chapter 8 Safety Instructions.....	36
Copyright Information.....	38

Chapter 1 Packing List

Power Adapter

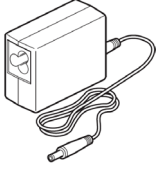

Power Cord

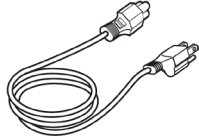

Appearance may vary depending on county/ region

USB 3.0 Cable-2m
(Type B - Type A)

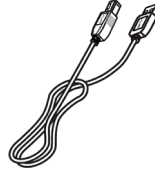

Remote Control



Metal Plate A

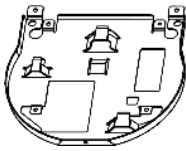

Metal Plate B

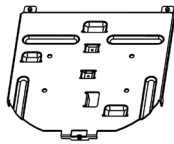

M3 Screws
Silver x8/ Black x2



3PIN-2PIN Connector

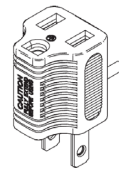

(For Japan only)

Chapter 2 Product Appearance

2.1 I/O interface

Front

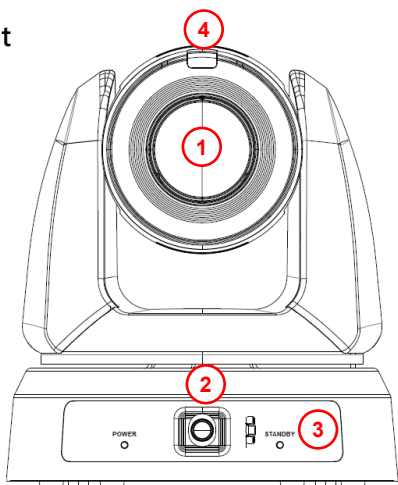

Back

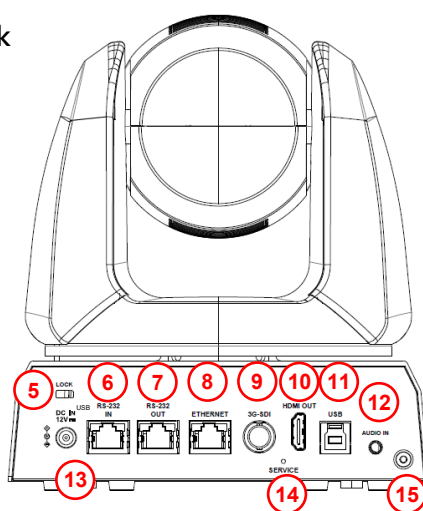

NO.	項目	功能說明
1.	Main camera lens	PTZ camera lens
2.	Panoramic lens	Panoramic camera lens
3.	LED indicators	Displaying the status of the camera, please refer to 2.2 LED Indicator
4.	Tally Lamp	Displaying the Tally Lamp status of the camera
5.	Lock	Safety lock slot
6.	RS232 IN	RS-232 port, up to 7 cameras can be connected. Pin out please refer to 3.3.2 RS-232 Pin Definition
7.	RS232 OUT	
8.	Ethernet	Network port, support PoE+ (IEEE802.3at)
9.	3G-SDI	3G-SDI output (BNC 75Ω · support SMPTE 425M)
10.	HDMI OUT	HDMI output
11.	USB3.0	Connecting to the USB port of the computer and providing USB signal images
12.	Audio In	3.5mm LINE IN
13.	DC IN 12V	DC supply connecting port
14.	Service	Safety lock slot
15.	Lock	Safety lock slot

2.2 LED Indicator

Status	Power	Standby
Power not connected	No light	No light
Startup in progress (initialization)	Green	Orange
Power on (In use)	Green	No light
Standby	No light	Orange
Tracking / Framing mode	Green Flickering	Green Flickering
Privacy mode	Orange	No light

2.3 Tally Lamp

The Tally lamp function may be enabled through the RS232 command. Please refer to RS-232 command set document

Chapter 3 Installation Instructions

3.1 Scenario

VC-TR61 supported tracking distance: 2-18m

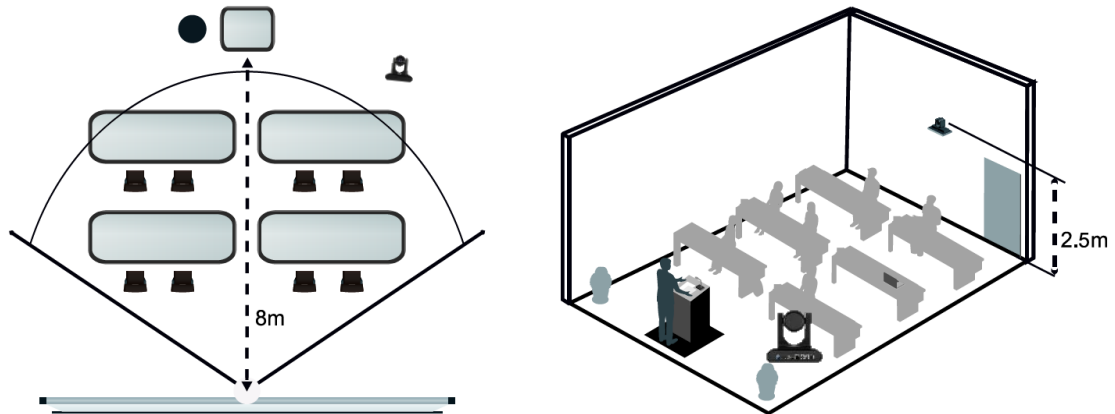

Note 為保持最佳追蹤效果, 請避免背景中的海報/顯示器 等物品出現人像圖案

3.2 Instruction for installation

Installation and connection of HD camera requires special skills. To install by yourself, please follow necessary steps, ensure steady and tight installation of the device, and pay attention to your safety to avoid any accident.

- 3.2.1 Ensure the safety of the installation environment. Please do not install the device on unstable ceiling or in a place where the device is in danger of falling to avoid any accident.
- 3.2.2 Please check whether accessories in the box are complete or not. Please contact the supplier for any shortage, and make sure to keep the accessories in the box intact.
- 3.2.3 Please choose a proper place for installation of camera in advance. Please determine an installation place according to the following requirements
 - (A) Confirm the position for the object to be captured.
 - (B) Confirm whether the camera is set at a proper distance from other light sources

3.2.4 Handling Instructions

- Do not grab the camera head by hand when handling the device
- Do not rotate the camera head. Improper rotation may result in breakdown of the camera

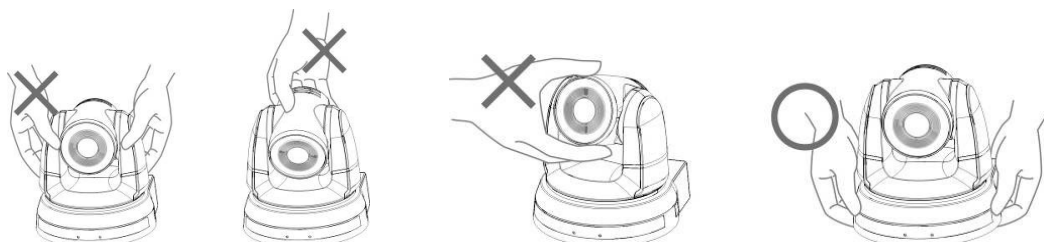

- Before installation, please confirm the orientation of the machine relative to the object to be captured
- It is recommended that the machine should be set at a distance of more than 1.5 meter away from the object to be captured. Please adjust for a best distance according to the magnification of the lens

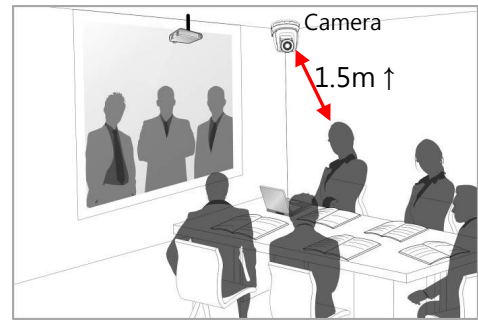

- The Camera (including metal plates) is weighed at about 2.7 kg. If it is to be installed on the ceiling, please use the hanger that has obtained UL security approval to prevent the machine from falling down.
- Please check whether the camera is installed securely on a regular basis.

3.2.5 If you would like to install the camera on the desk

Please place the camera on a flat desk to ensure the normal vertical and horizontal operation of the machine.

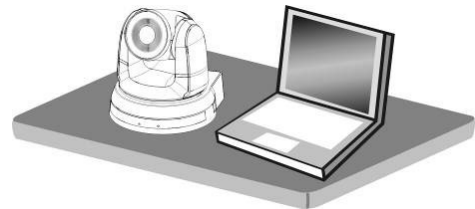

3.2.6 If you would like to install the camera on the ceiling

(A) Prepare for the parts and equipment required during the installation

- Accessories in the box (metal plates A, B, M3 screw silver x 8, black x 2)
- Screw for locking on ceiling mounted hanger x 4
- Drilling machine, screw driver, ladder
- Camera and Metal dimension please refer to Chapter 7 Addendum

(B) Installation steps

1. Fix the metal plate A on the machine base with 4 M3 silver screws

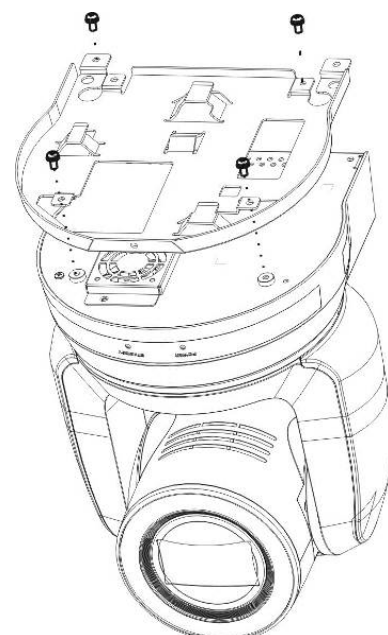

2. Lock the metal plate B on ceiling mounted hanger

※Caution :

- Please use the hanger that has obtained UL security approval
- Please reserve the hole for the connecting wires of the camera

3. Combine the metal plate A and the metal plate B

(1) Push the metal plate A up to the ceiling and then to the right to latch the metal plate B

(2) And then secure with 2 M3 silver screws and 1 M3 black screw

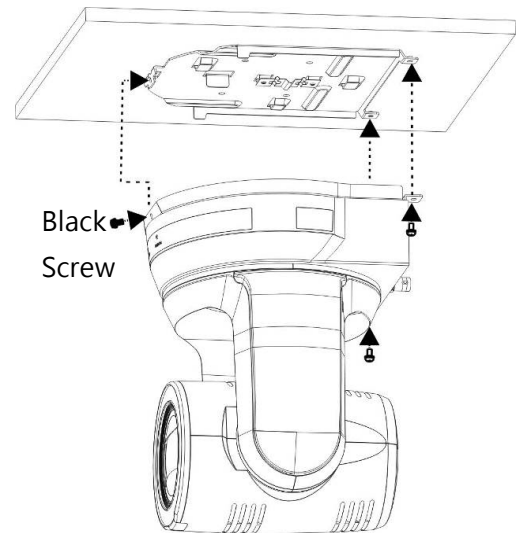

3.2.1 How to remove

1. Remove the connecting wires from the camera
2. Uninstall the camera together with the ceiling, loosen the three screws that fix the metal plates A and B and push to the left to remove the machine

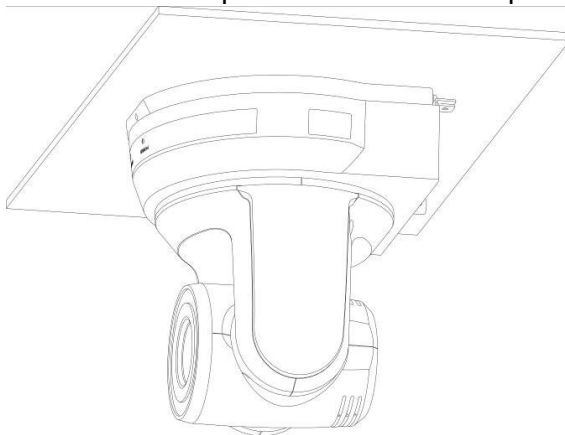

3. Then remove the screws on the hanger and the machine

3.3 Connection

3.3.1 Connecting devices

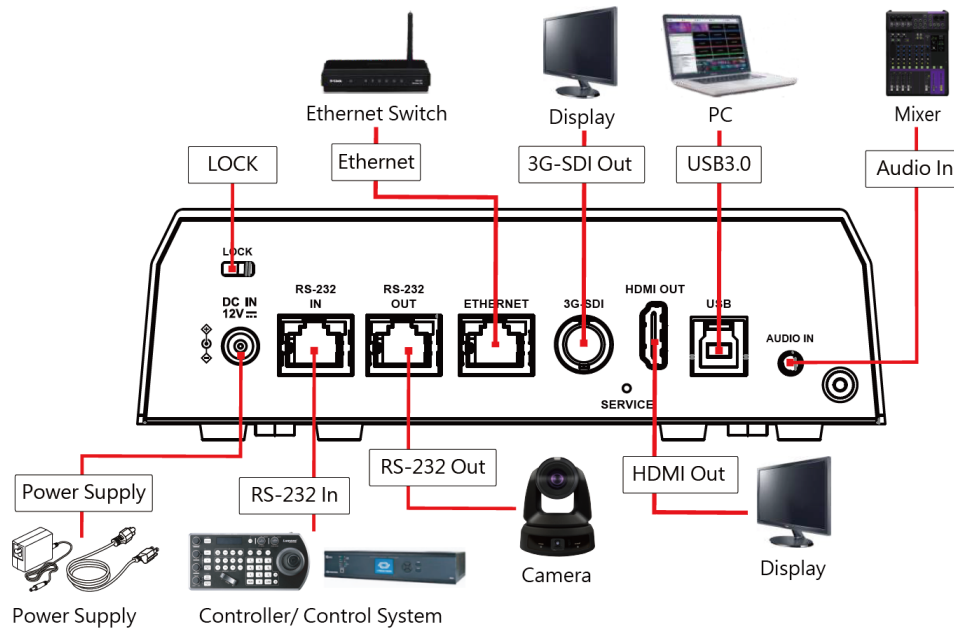

Note Ethernet port supports PoE+ (IEEE802.3at)

3.3.2 RS-232 Pin Definition

Note Daisy Chain supports 7 cameras connected

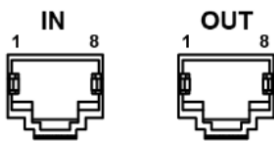

Pin No.	IN	OUT
1	NA	NA
2	NA	NA
3	GND	GND
4	TX	RX
5	RX	TX
6	DTR	DSR
7	NA	NA
8	NA	NA

Chapter 4 Remote Control and Setting Menu

4.1 Remote control

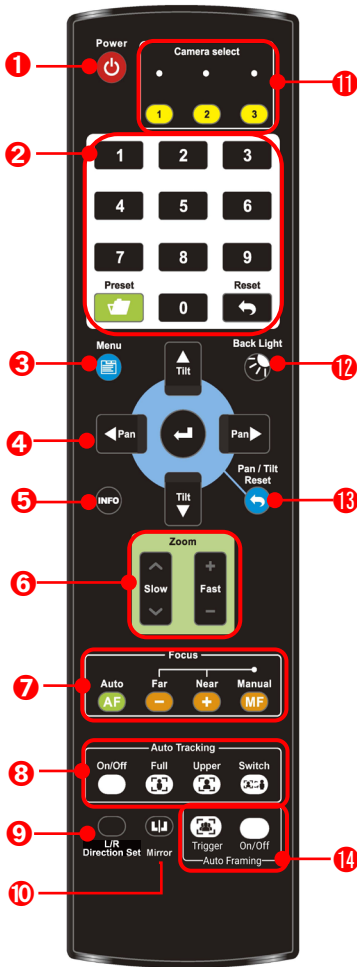

No.	Item	Description
1.	Power	Power on/ off
2.	Preset	<ul style="list-style-type: none"> 0-9: Click to call the preset Preset: Assign a preset number(0~9) to save the current position data Reset: Select a preset number(0~9) to clear the its position data
3.	Menu	Display OSD menu
4.	Pan/ Tilt/ Enter	<ul style="list-style-type: none"> Pan/ Tilt: Move the camera head Home/ Enter: Go back to Home position / Execute
5.	Info	Status information
6.	Zoom	<ul style="list-style-type: none"> Fast: zoom with high speed Slow: zoom with low speed
7.	Focus	<ul style="list-style-type: none"> Auto: Auto focus Manual: Enable Manual Focus Far/ Near: Adjust the focus in Manual mode
8.	Auto Tracking	<ul style="list-style-type: none"> On/Off: Enable/Disable Auto Tracking Full: Frames presenter' s full body Upper: Frames presenter' s torso Switch: Switch target to a different presenter
9.	L/R Direction Set	L/R Direction / Normal
10.	Mirror	Rotate the image (OFF / Mirror / Flip / Rotate)
11.	Camera select	Choose Camera ID 1 ~ 3
12.	Back Light	Turn on/off back light compensation
13.	Pan/Tilt Reset	Clear the Pan/Tilt setting
14.	Auto Framing	<ul style="list-style-type: none"> On/Off: Enable/ Disable Auto framing. Trigger: (VC-TR61 not supported.)

4.2 Setting Menu

Press [MENU] on the remote control to call the on-screen menu. Default is indicated in bold.

Layer 1	Layer 2	Layer 3	Description
Exposure	Mode	Full Auto / Shutter Pri/ Iris Pri/ Manual/ White Board	Exposure mode setting
	Exposure Comp	On/ Off	Turn on/off Exposure Compensation.
	Exposure Comp. Level	-6~ C ~4	Adjustable after Exposure Comp. s activated
	Spot Light	On/ Off	Turn on/ off Spot Light
	Spot Light Position	X(0~6)Y(0~4)	Adjustable after Spot Light is activated
	Gain Limit	8~ 30 dB	Max. limit value of electron gain
	WDR	Off / 1/ 2/ 3	WDR settings
	Anti-Flicker	50Hz/ 60Hz/ Off	Activate the anti-flicker function to eliminate flicker from lighting.
	Shutter Speed	1/10000~1/25	Adjustable when the Exposure mode is set to Shutter Pri or Manual
	Iris Level	F1.8~ C ~F11/ Off	Adjustable when the Exposure mode is set to IRIS Pri or Manual
Gain Level	0~30dB	Adjustable when the Exposure mode is set to Manual	
White Balance	Mode	1.Auto 2.Indoor 3.Outdoor 4.One Push WB 5.ATW 6.Manual 7.Sodium Lamp	Select the color temperature 1. 4000k ~ 7000k 2. 3200k 3. 5800k 4. 1700k ~ 10000k 5. 1700k ~ 10000k 6. Manual 7. 2800k
	One Push Trigger	ENTER	One push trigger
	Manual Red	0~ C ~128	Adjustable when the white balance mode is set to Manual
	Manual Blue	0~ C ~128	Adjustable when the white balance mode is set to Manual
Tracking	Type	Auto Tracking / Auto Framing	
Picture	3D NR	Off / 1~ C ~7	3D noise reduction

Layer 1	Layer 2	Layer 3	Description
	Image Mode	<u>Default</u> / Custom	Users can customize the selected image mode
	Gamma	0~ <u>C</u> ~3	Adjustable when Image Mode set to Custom
	Brightness	0~ <u>C</u> ~25	Adjustable when Image Mode set to Custom
	Contrast	0~ <u>C</u> ~25	Adjustable when Image Mode set to Custom
	Saturation	0~ <u>C</u> ~25	Adjustable when Image Mode set to Custom
	Sharpness	0~ <u>C</u> ~11	
Pan Tilt Zoom	Pan/Tilt Limit	On/ <u>Off</u>	On/ Off the angle limit setting
	Pan Right Limit	0~ <u>170</u>	Limit the panning angle (right side)
	Pan Left Limit	<u>-170</u> ~0	Limit the panning angle (left side)
	Tilt UP Limit	0~ <u>90</u>	Limit the tilt angle (up)
	Tilt Down Limit	<u>-30</u> ~0	Limit the tilt angle (down)
	Pan Flip	On/ <u>Off</u>	Reverses the Pan direction
	Tilt Flip	On/ <u>Off</u>	Reverses the Tilt direction
	Preset Speed	5/ 25/ 50/ 80/ 120 deg/sec	Set the robotic and zoom speed of the camera
	PTZ Speed Comp	On/ <u>Off</u>	Enable the zoom speed independent from the robotic speed
	D-Zoom Mode	<u>On</u> / Off	Set the digital zoom limit
	Limit	<u>2x</u> ~8x	<div style="border: 1px solid gray; padding: 2px; width: fit-content;">Note</div> Digital zoom not supported when: <ul style="list-style-type: none"> ■ 4K resolution ■ 1080P/ 720P, Stream/ UVC outputs
D-Effect	Mirror	<u>Off</u> / Mirror/ Flip/ Mirror+Flip	Activate image rotation and/or mirroring
Auto Focus	AF Sensitivity	Low/ <u>Middle</u> / High	Changes the sensitivity of the auto-focus.

Layer 1	Layer 2	Layer 3	Description
	AF Frame	Center Area/ All Area	Changes the focusing zone to the selected mode. <ul style="list-style-type: none"> Central area: focusing will be performed based on the center. Full Frame: focusing will be calculated based on the full screen
	Zoom tracking	On/ <u>Off</u>	The focus mode during lens zooming (It can be set in the Manual Focus (MF) mode)
	PTZ Assist	On/ <u>Off</u>	When PTZ Assist is enabled and PTZ control is in operation, the focus performs only once upon immediate execution. The focus will not be triggered afterward when the scene changes (It can be set in the Manual Focus (MF) mode)
Ethernet	DHCP	<u>On</u> / Off	Enable/Disable dynamic host configuration
	IP Address	<u>192.168.100.100</u>	Configurable when DHCP is set to Off
	Subnet mask	<u>255.255.255.0</u>	
	Gateway	<u>192.168.100.254</u>	
Audio	Audio In	<u>Line In</u>	3.5m Line In
	Audio Enable	On/ <u>Off</u>	Turn on/off audio output
	Audio Volume	0~ <u>C</u> ~10	Volume Setting
	Audio Delay	On/ <u>Off</u>	When the audio is not synchronized with the video, enable this function to set the audio delay time
	Audio Delay Time(ms)	<u>-10</u> ~-500ms	Set audio delay time
	Encode Sample Rate	<u>48 (AAC)</u>	Set the encode type and sample rate
System	Prompt	On/ <u>Off</u>	Turn on/off the prompt information on the display

Layer 1	Layer 2	Layer 3	Description
	IR Receive	<u>On</u> / Off	On/off the infrared reception When it' s Off, the remote control will not be able to control the camera. Disconnect and then plug the power cable to re-activate.
	IR Select	<u>1</u> / 2/ 3	Match the remote control's IR setting with the camera's IR setting.
	Tally Lamp	On/ <u>Off</u>	Enables the camera's tally lamp.
	Tally CMMD Mode	Normal/ <u>Link</u>	Set whether the tally lamp is linked with RS232 commands. <ul style="list-style-type: none"> ▪ Normal (Not linked): The tally lamp and mode are set separately. <ul style="list-style-type: none"> ➤ When the tally lamp is on but the default mode is off, an additional command is required to set the indicator light mode ➤ When the tally lamp is off, setting the mode will not trigger the indicator light ▪ Link: <ul style="list-style-type: none"> ➤ When the tally lamp is on, the default mode is a red light ➤ When the tally lamp is off, setting the mode will turn on the tally lamp.
	Tracking Led Status	On/ <u>Off</u>	When enabled, LED on the front panel will flash green while the camera is tracking.
	Language	<u>English</u> / 中文	
	Initial Position	<u>Last MEM</u> / 1st Preset	After turning on the camera, you can select the lens to be returned to <u>Last MEM</u> or 1st Preset <small>Note</small> 1st Preset =Preset 0
	Motionless Preset	On/ <u>Off</u>	The image will freeze when Preset is executed. Freeze will be released after Preset is completed

Layer 1	Layer 2	Layer 3	Description
	Privacy Mode	On/ <u>Off</u>	When the camera is turned off via the remote control or software, the lens will automatically turn to the bottom right to ensure the user' s privacy
	Protocol	<u>VISCA</u>	Supports VISCA protocol
	Baud Rate	<u>9600</u> /38400	Transmission speed of the control signal
	VISCA Address	<u>0</u> ~7	The camera ID address can be assigned.
	Output Mode	<u>2160P 59.94</u> /50/29.97/25 1080p 59.94/50/29.97/25 720p 59.94/50/29.97/25 1080i 59.94/50	Set the output resolution
	Factory Reset	On/ <u>Off</u>	Resume the factory default setting
Status			Display the current setting information

Chapter 5 Network setting and Web interface

5.1 Connecting Camera to Network

5.1.1 Connection

Two common connection methods are shown below

1. Connect via switch or router

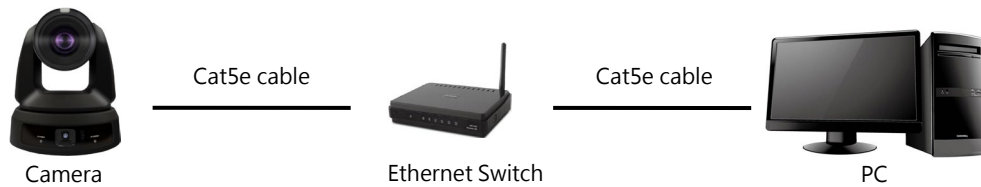

2. Connect directly via an Ethernet cable, and the computer's IP address must be modified to match the network segment used by the camera.

E.g.: the camera's default IP address is 192.168.100.100, the computer's IP address should be set to the same segment, such as 192.168.100.101, to connect properly to the camera.

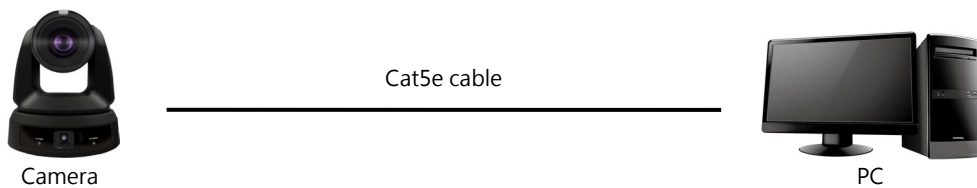

- Modify the PC's network settings

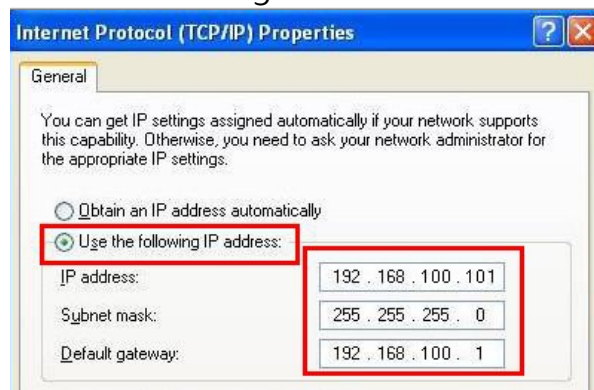

5.1.2 Use a Browser to view Images

- Open the browser, and enter the IP address of the camera in the address bar
E.g.: <http://192.168.100.100> (default IP address)
- Enter the Username and Password

Note For the first-time login, please refer to [5.2.11 System-User](#) to change the default password

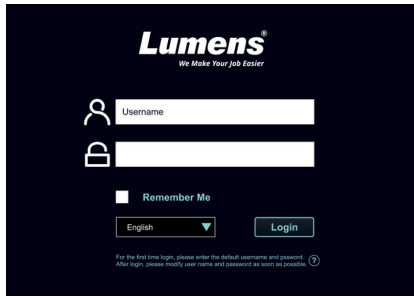

Lumens IP Camera

- Account: admin
- Password: 9999

5.1.3 Use a RTSP Player to View Images

Free software can be used for RTSP connection, such as VLC, Quick Time and PotPlayer.

RTSP connection address formats are as follows:

- RTSP Stream 1 => <rtsp://camera IP:8554/hevc>
<rtsp://camera IP:8557/h264>
- RTSP Stream 2 => <rtsp://camera IP:8556/h264>
- Panoramic Lens View => <rtsp://camera IP:8553/h264>

If password authentication is enabled, the RTSP connection address is as follows:

- [rtsp://Username:Password@VC IP address:8557/stream1\(or stream2\)](rtsp://Username:Password@VC IP address:8557/stream1(or stream2))
- To enable password authentication function, please refer to [5.2.9](#)

[System-Network](#)

Example:

Open the VLC software, click [Open Network Streaming], and enter the URL:

<rtsp://192.168.100.150:8557/h264>

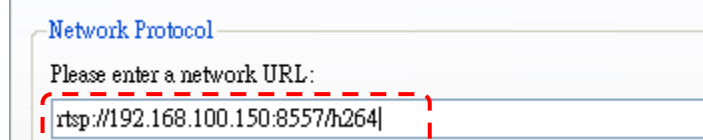
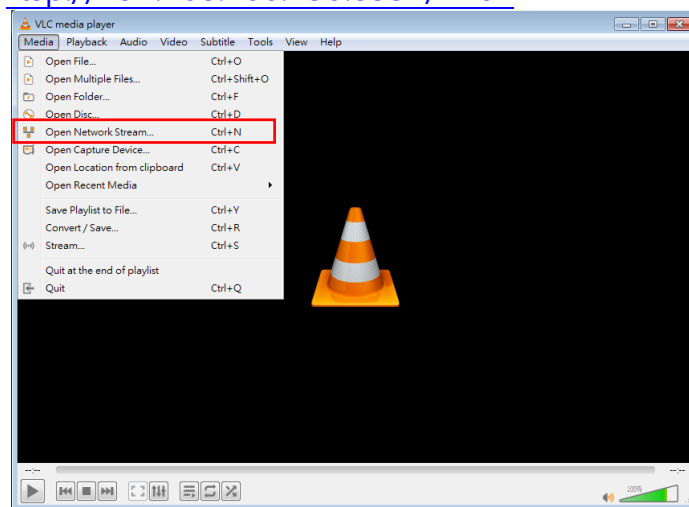

5.2 Web interface functions

5.2.1 Login

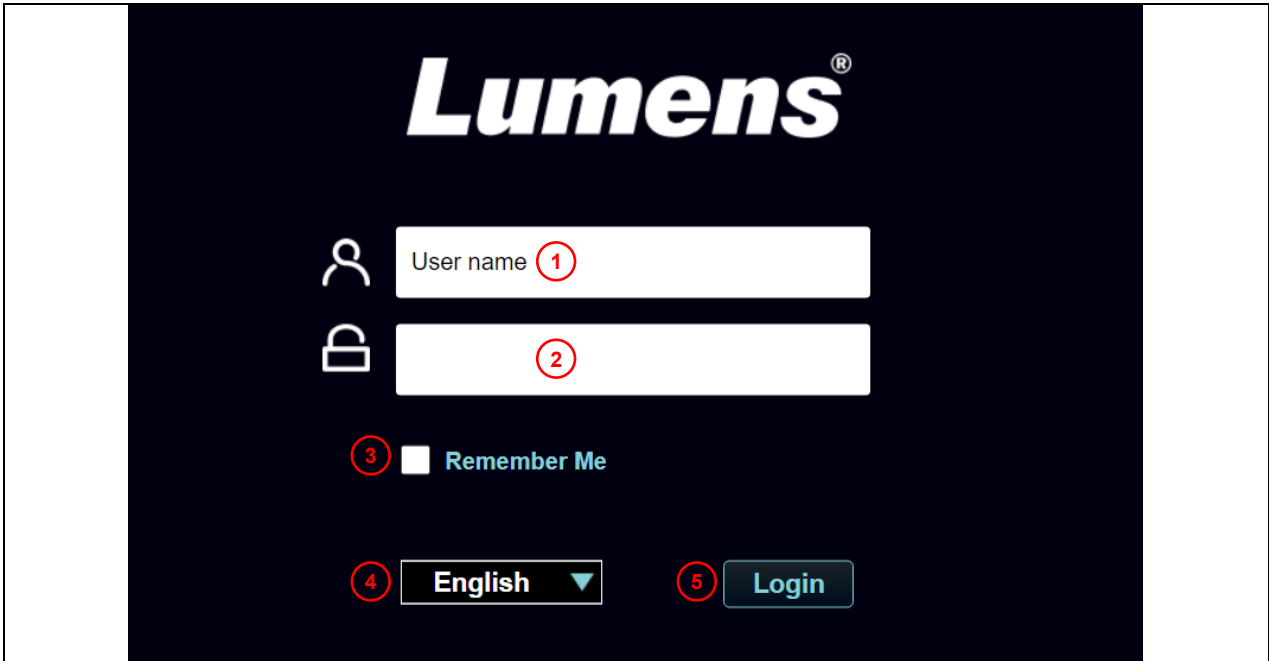

No	Item	Function Descriptions
1	User name	Enter user login account (default: admin)
2	Password	Enter user password (default: 9999) <small>Note</small> For the first-time login, please refer to 5.2.11 System-User to change the default password
3	Remember Me	Save user name and password. When you log in next time, there is no need to re-enter them.
4	Language	Supporting English/ Traditional Chinese/ Simplified Chinese
5	Login	Log in to the web interface.

5.2.2 Live View



No	Item	Function Descriptions
1	Camera ID/ Location	Display camera ID/ Location Please refer to 5.2.7 System-Device
2	Preview screen	Display the current view of the camera
3	Preset setting	Select the number first and then select Store or Load
4	Pan/Tilt	Adjust the Pan/Tilt position of the camera
5	Zoom	Zoom In/Zoom Out
6	AF/ MF	Switch Auto Focus/ Manual Focus.
7	Pan/ Tilt Speed	Adjust the pan/ tilt speed
8	Zoom speed	Adjust the zoom speed
9	Tracking	Enable/ Disable Auto Tracking/ Auto Framing Note Select Auto Tracking or Auto Framing.
10	Camera Setting	Please refer to 5.2.3 Live View - Camera Setting for related settings

5.2.3 Live View - Camera Setting



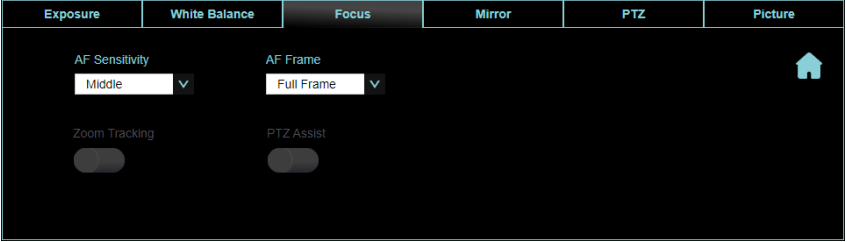

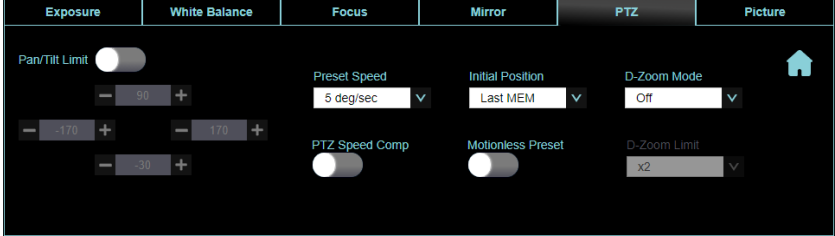
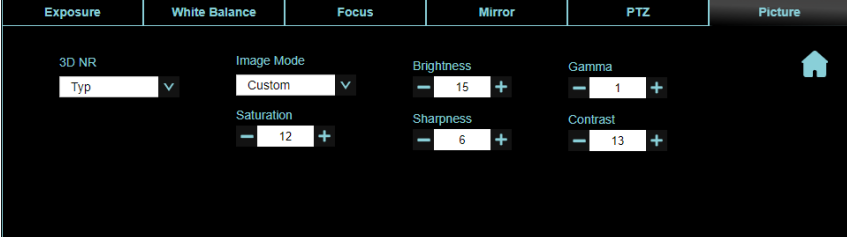
No	Item	Descriptions
1.	Exposure	<ul style="list-style-type: none"> ■ Mode: Exposure mode (Full Auto/ Shutter Pri/ Iris Pri/ Manual/ White Board) ■ WDR: Set the level to change the dynamic range of the picture. ■ Exposure Comp. Level: Select exposure compensation level ■ Gain Level: Adjust gain level (adjustable under “Manual” mode.) ■ Iris Level: Adjust the aperture (adjustable under “Manual” or “Iris Pri” mode) ■ Shutter Speed: Adjust the shutter speed (adjustable under “Manual” or “Shutter Pri” mode) ■ Anti-Flicker: Activate the anti-flicker function to eliminate flicker from lighting.
2.	White Balance	 <ul style="list-style-type: none"> ■ Mode: Select the color temperature ■ One Push: Executes a one time color temperature adjustment (configurable in [One Push WB] mode) ■ Manual Red/Blue: Manually adjust red/blue color temperature
3.	Focus	 <ul style="list-style-type: none"> ■ AF Sensitivity: change the sensitivity of the auto focus. ■ AF Frame: Changes the focusing zone to the selected mode. ■ Zoom Tracking: The focus mode during lens zooming (can be set in “Manual”) ■ PTZ Assist: Check whether auto focus is enabled if there is any changes of PTZ (can be set in “Manual”) <p>Note When PTZ Assist is enabled, focus will be triggered after PTZ control, but won’ t be triggered when the scene changes.</p>

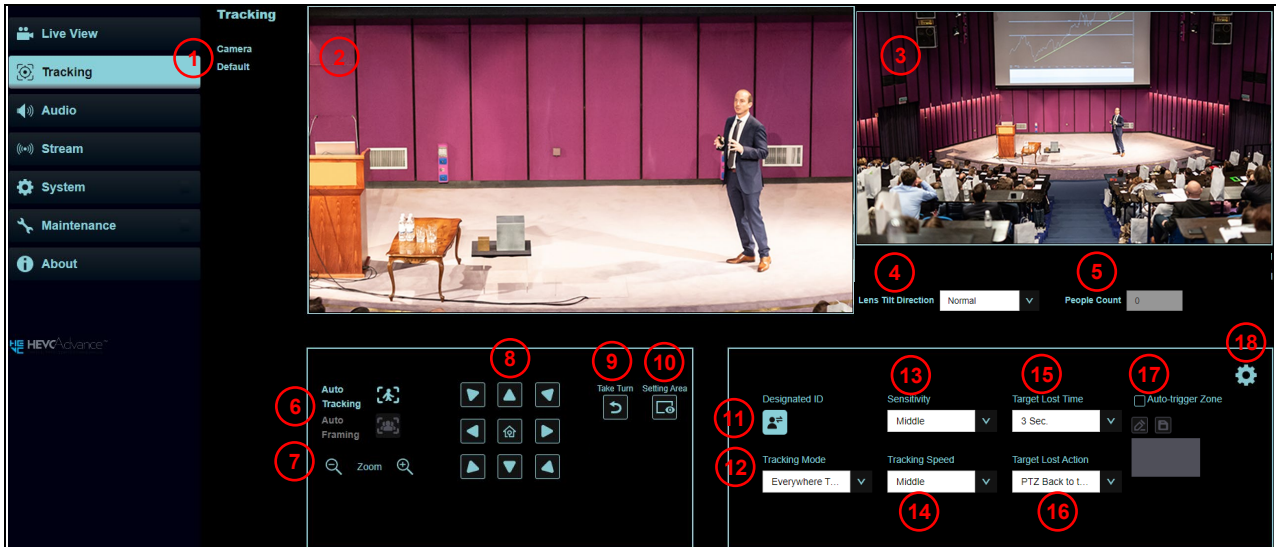

4.	Mirror	 <ul style="list-style-type: none"> ■ Mirror: Set image mirroring ■ Flip: Set the mode at which the image is turned
5.	Pan Tilt Zoom (PTZ)	 <ul style="list-style-type: none"> ■ Pan/Tilt Limit: Enable to set the pan/tilt limit ■ Pan/Tilt Flip: Set On and the Pan/Tilt directions will be reversed. ■ Preset Speed: Set the rotation speed of the cradle head when Preset is executed ■ Initial Position: Set the camera lens to return to the Last MEM or the 1st Preset after POWER ON <ul style="list-style-type: none"> Note 1st Preset= Preset 0 ■ D-Zoom Mode: Enable/ Disable digital zoom ■ D-Zoom Limit: Set the digital zoom limit <ul style="list-style-type: none"> Note 4K resolution not support digital zoom ■ PTZ Speed Comp: The Pan/Tilt robotic speed will vary according to the zoom position ■ Motionless Preset: Image will freeze when a preset is activated. Freeze will be released after Preset completed
6.	Picture	 <ul style="list-style-type: none"> ■ 3D noise reduction: 3D noise reduction settings ■ Image Mode: Users can customize the image parameters. ■ Brightness: Adjustable when Image Mode set to Custom ■ Gamma: Adjustable when Image Mode set to Custom ■ Saturation: Adjustable when Image Mode set to Custom ■ Sharpness: Adjustable the sharpness level ■ Contrast: Adjustable when Image Mode set to Custom
7.	PTZ Control	Go back to PTZ Control page

5.2.4 Tracking

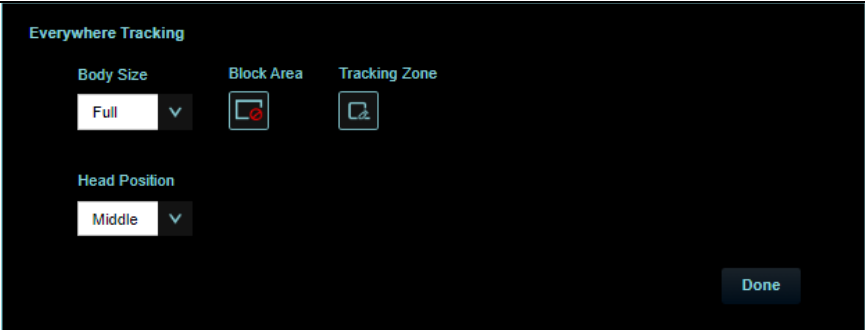

No	Item	Descriptions
1.	Camera ID/Location	Display camera ID/ location. Please refer to 5.2.7 System-Device
2.	PTZ preview	Display the current view of the main lens.
3.	Panoramic preview	Display the current view of the panoramic lens
4.	Lens Tilt Direction	Set the tilt direction for the panoramic lens
5.	People Count	Display the calculated number of people in the screen.
6.	Tracking	<p>Enable/ Disable Auto Tracking/ Auto Framing</p> <p>Note</p> <ul style="list-style-type: none"> ▪ Select Auto Tracking or Auto Framing. ▪ Not applicable with [Center Stage] mode
7.	Zoom	Zoom In/Zoom Out image
8.	Pan/ Tilt	Adjust the Pan/Tilt of the camera Note PTZ setting is not supported when tracking function enabled.
9.	Take turn	Switch the target. Note Applicable for [Auto Tracking] mode only
10.	Setting Area	Display the configured tracking and blocked areas in the panoramic preview screen. Note Applicable for [Auto Tracking] mode only
11.	Designated ID	Display individuals the camera has detected. Target ID can be switched by clicking on a subject with the mouse. Note Not applicable for [Center Stage] mode
12.	Tracking Mode	Set the Tracking Mode <ul style="list-style-type: none"> ▪ Voice Tracking: Voice Tracking ▪ Auto Tracking: Everywhere Tracking/ Stage Tracking/ Partition Tracking ▪ Center Stage ▪ Auto Framing: Auto Framing/ Partition Framing
13.	Sensitivity	Set tracking sensitivity
14.	Tracking Speed	Set tracking speed

15.	Target Lost Time	Set a delay to take action after a tracking target is lost
16.	Target Lost Action	Set the action after a tracking target is lost
17.	Auto-trigger zone	<p>After a person enters the area for 3 seconds, tracking/ framing will be triggered.</p> <p>Note</p> <ul style="list-style-type: none"> ▪ [Tracking Mode]> [Center Stage] is not supported. ▪ Enabling Auto Tracking/ Auto Framing will disable the [Auto-trigger zone] function. ▪ Stopping Auto Tracking/ Auto Framing will reactivate the [Auto-trigger zone] function.
18.	Tracking Mode Setting	Advanced settings for tracking.
18.1	Everywhere tracking	 <ul style="list-style-type: none"> ■ Body Size: Set Full/ Half Body ■ Head Position: Set the head position of the person in the screen ■ Block Area: Click the left mouse button to draw a frame on the panoramic view to set a blocked area. ■ Tracking Zone: Click the left mouse button to draw a frame on the panoramic view to set a designated tracking area.
18.2	Stage Tracking	 <ul style="list-style-type: none"> ■ Body Size: Set Full/ Half Body ■ Head Position: Set the head position of the person in the screen ■ Block Area: Click the left mouse button to draw a frame on the panoramic view to set a block area. ■ Tracking Zone: Click the left mouse button to draw a frame on the panoramic view to set a designated tracking area.
18.3	Partition Tracking	<p>Set Partition Tracking. Up to 4 zones can be set</p> <p>When a person enters the specific zone, the camera switches to the partition. Tracking will not be performed within the zone, while</p>

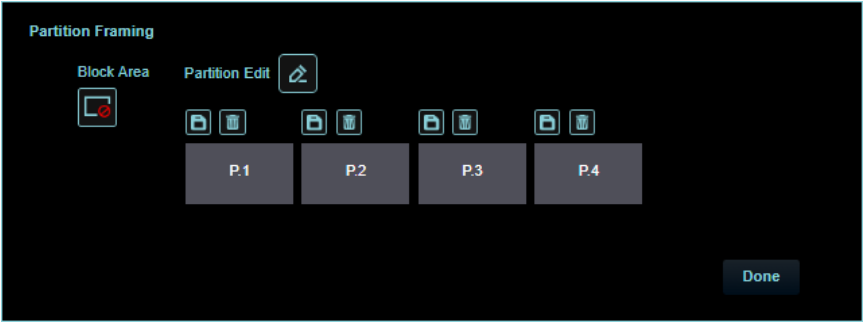
		<p>outside the zone, everywhere tracking will be active.</p>  <p>The screenshot shows the 'Partition Tracking' interface. It includes a 'Body Tracking' dropdown set to 'Full', a 'Head Position' dropdown set to 'Middle', and a 'Block Area' icon. Below these are four partition buttons labeled P1, P2, P3, and P4, each with a lock icon. A 'Partition Edit' icon is at the top right, and a 'Done' button is at the bottom right.</p> <ul style="list-style-type: none"> ■ Head Position: Set the head position of the person on the screen ■ Block Area: Click into the Edit mode, frame by holding the left mouse button and set the blocked area ■ Block Area: Click the left mouse button to draw a frame on the panoramic view to set a blocked area. ■ Partition Edit: Edit and save partition positions
18.4	Auto Framing	 <p>The screenshot shows the 'Auto Framing' interface. It features a 'Block Area' icon and a 'Done' button at the bottom right.</p> <ul style="list-style-type: none"> ■ Block Area: Click into the Edit mode, frame by holding the left mouse button and set the block area
18.5	Partition Framing	 <p>The screenshot shows the 'Partition Framing' interface. It includes a 'Block Area' icon, a 'Partition Edit' icon, and four partition buttons labeled P1, P2, P3, and P4. Each partition button has a lock icon and a trash icon. A 'Done' button is at the bottom right.</p> <ul style="list-style-type: none"> ■ Block Area: Click the left mouse button to draw a frame on the panoramic view to set a block area. ■ Partition Edit: Edit and save partition positions

5.2.5 Audio

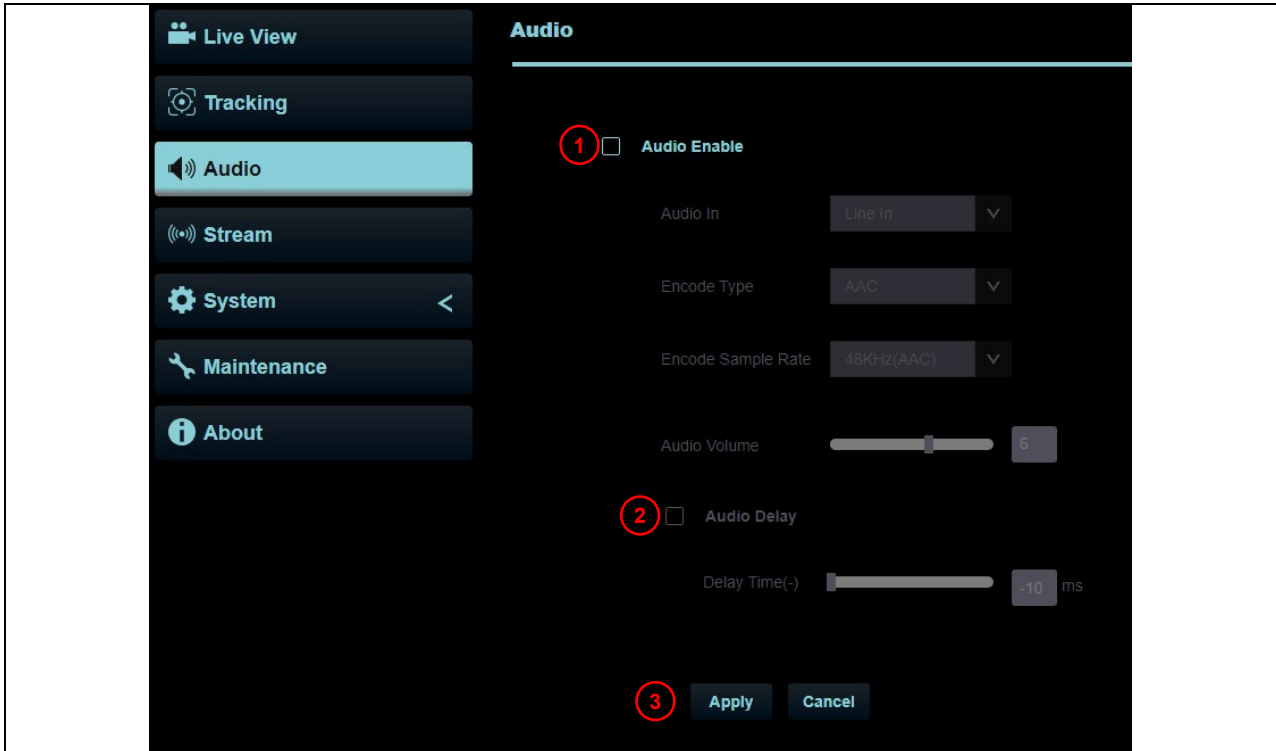

No	Item	Descriptions
1	Audio Enable	Select to enable Audio function <ul style="list-style-type: none"> ■ Audio In: Set Line In ■ Encode type: AAC ■ Encode sample rate: 48KHz(AAC) ■ Volume: Adjust Audio Volume
2	Audio Delay	Check to set the audio delay time (10 ~ -500 ms)
3	Apply/ Cancel	Apply/ Cancel Audio Settings

5.2.6 Stream

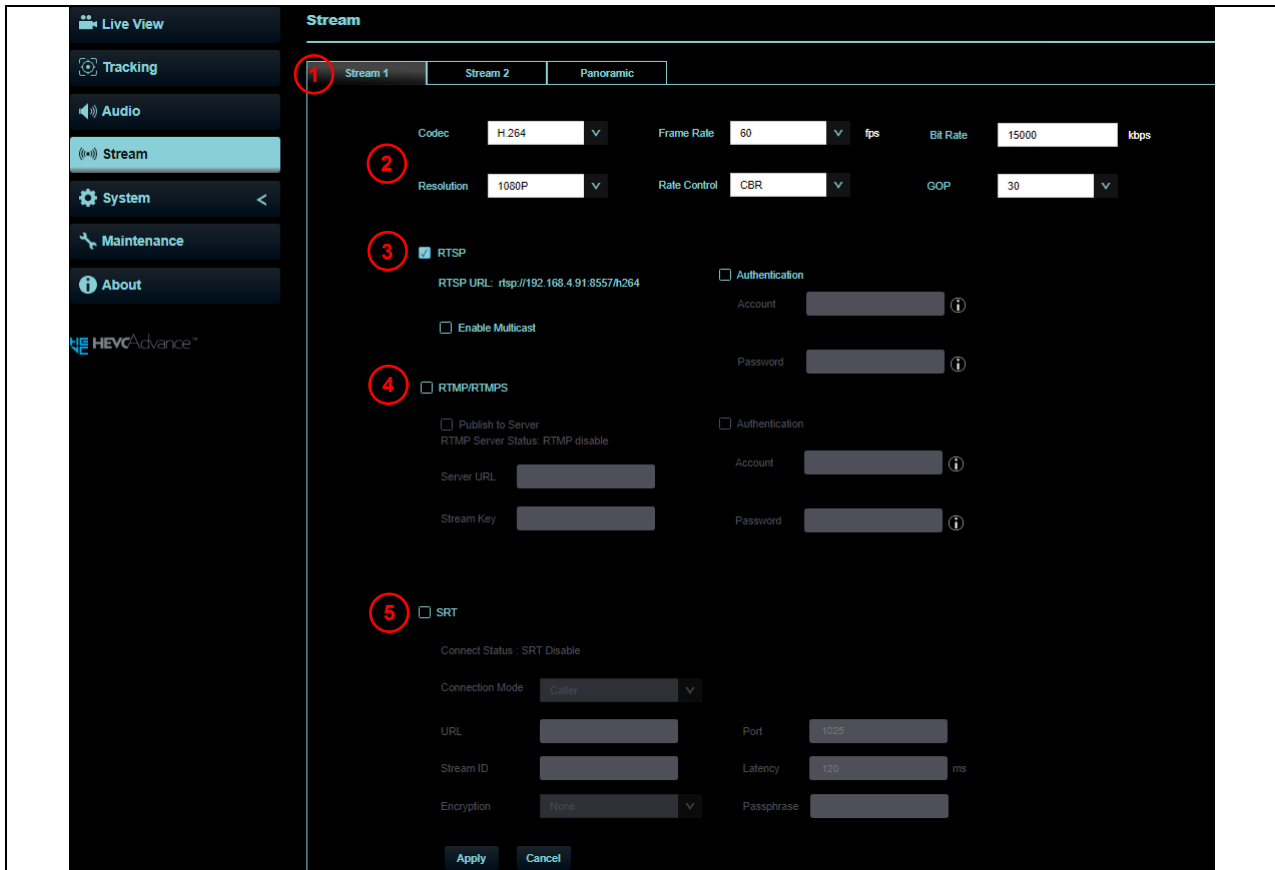

No	Item	Descriptions
1	Stream	Supporting 2 streams and panoramic view stream outputs
2	Stream settings	Please refer to 5.2.6.1 Stream Settings .
3	RTSP	<p>Select to enable RTSP</p> <ul style="list-style-type: none"> ■ Enable/ Disable Multicast Multicast is recommended when the stream is being watched by more than 4 viewers. ■ Enable/Disable Password Authentication <ul style="list-style-type: none"> ➢ Please refer to 5.1.3 Using RTSP Player to View the Images for the connection format. ➢ The username/ password is the same as the web login password of the camera, please refer to 5.2.11 System Settings - User to add/modify account information
4	RTMP/ RTMPS	<p>Use the RTMP URL provided by the RTMP service platform to publish the camera live view to the platform.</p> <p>For YouTube streaming, please refer to 5.2.5 Audio to turn on the audio function</p>
5	SRT	<ul style="list-style-type: none"> ■ Check to enable and set SRT streaming After the SRT streaming is opened, it will be connected automatically upon camera startup. ■ The port number must be set in the range above 1024 with a

		<p>maximum value of 65535</p> <p>Note The following ports are used by the camera. Setting the ports may result in connection issues.</p> <p>8554, 8556, 8557, 8080, 9090, 1935</p> <ul style="list-style-type: none"> Latency can be set between 20-8000 microseconds. (Default is 120 microseconds)
--	--	--

5.2.6.1 Streaming settings

Function		Stream 1	Stream 2
Encode Format		HEVC/ H.264	H.264
Resolution		4K/ 1080p/ 720p	720p
Bit rate	Bit rate	2,000~20,000	2,000~20,000
	Default	7,000	3,000
Rate Control		CBR / VBR	
Frame Rate/ Group of Pictures		Setting according to the supported resolution	

5.2.7 System - Device

Descriptions

Edit camera ID/ Location

- Camera ID: Supporting 1 - 32 characters
- Location: Supporting 1 - 30 characters
- Supporting English, Chinese and numbers. Special symbols such as "/" and "space" cannot be used

Note Modifying this field will also update the ONVIF device name/location.

5.2.8 System - Output

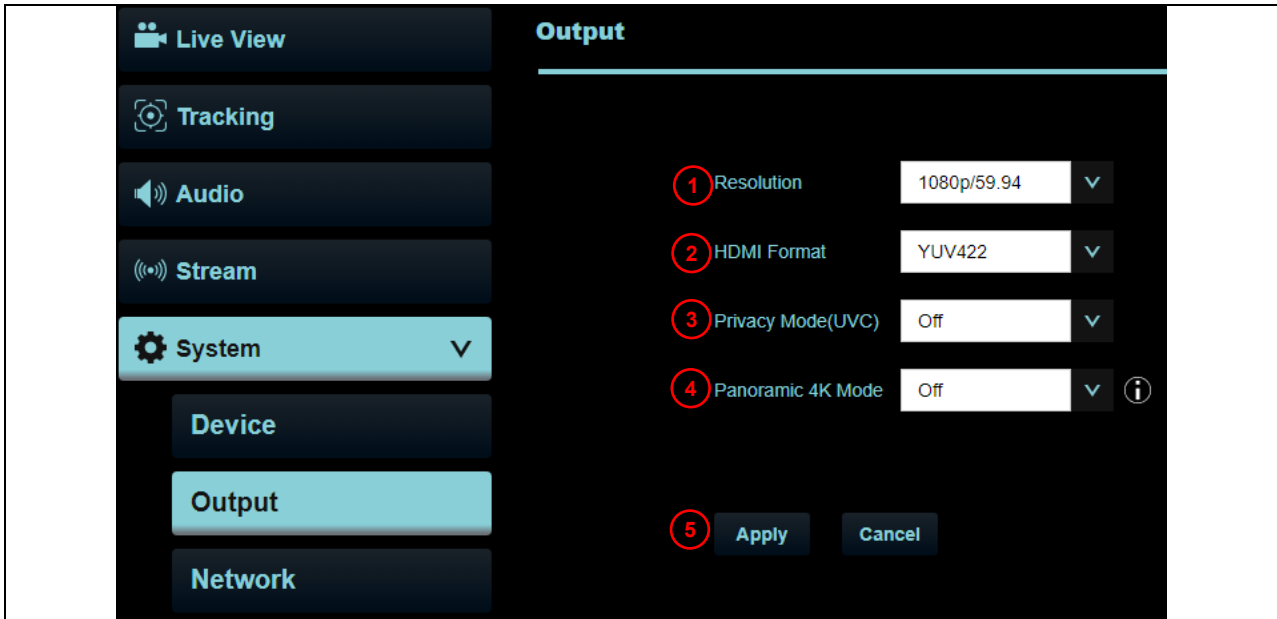

No	Item	Descriptions
1	Resolution	Set the resolution of the camera Note After changing resolution, the camera will restart. The browser will need to be refreshed.
2	HDMI Format	Supporting YUV422/ RGB
3	Privacy Mode (UVC)	After the privacy mode is enabled, when the camera is turned off via the remote control or software, the lens will automatically turn to the bottom right to ensure the user' s privacy.
4	Panoramic 4K Mode	Supports 4K output over Panoramic stream. Note <ul style="list-style-type: none"> ■ This mode is available when the system resolution is set to 4K at 60/30fps. ■ UVC is limited to 720p when Panoramic 4K mode is selected. ■ After changing resolution, the camera will restart. The browser will need to be refreshed.
5	Apply/ Cancel	Apply/ Cancel Setting

5.2.9 System - Network

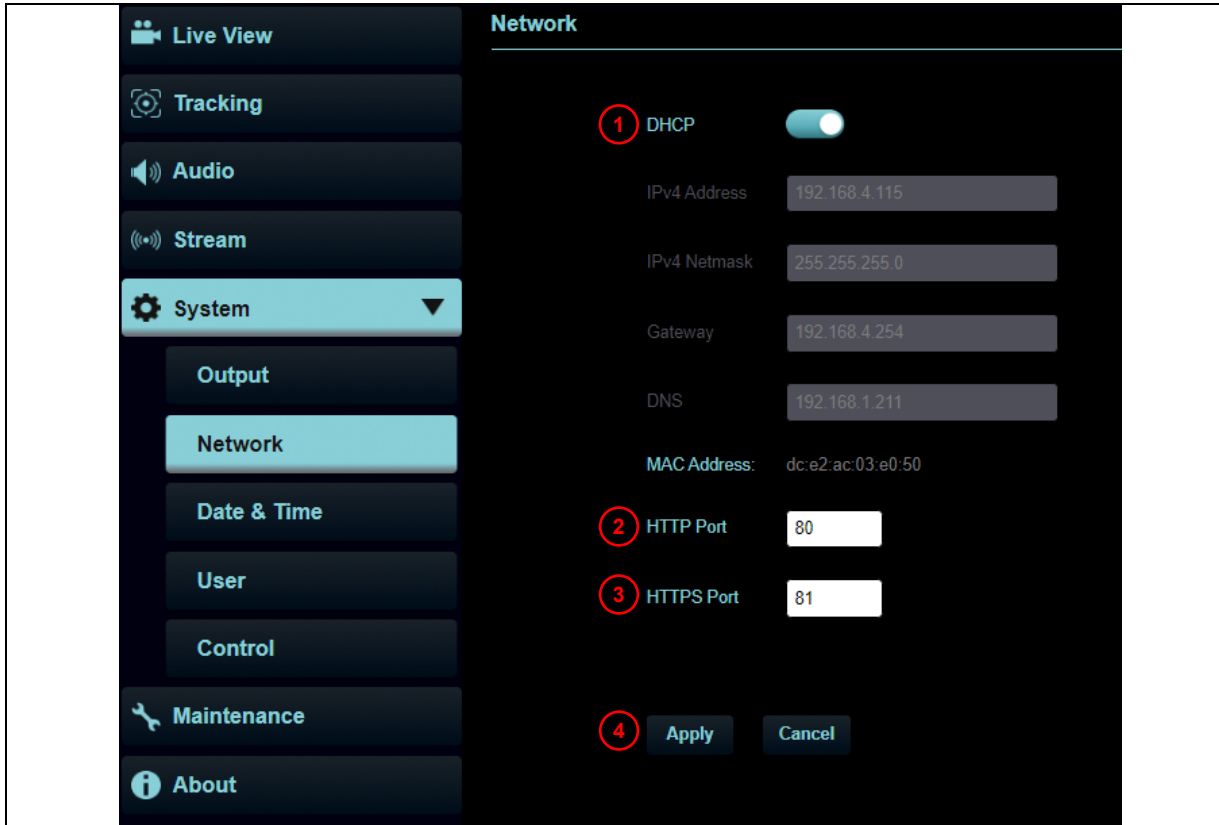

No	Item	Descriptions
1	DHCP	Camera network settings. Configurable when DHCP is set to Off.
2	HTTP Port	Set HTTP port. The default Port value is 80
3	HTTPS Port	Set HTTPS port. The default Port value is 81
4	Apply/ Cancel	Apply/ Cancel Setting

5.2.10 System - Date & Time

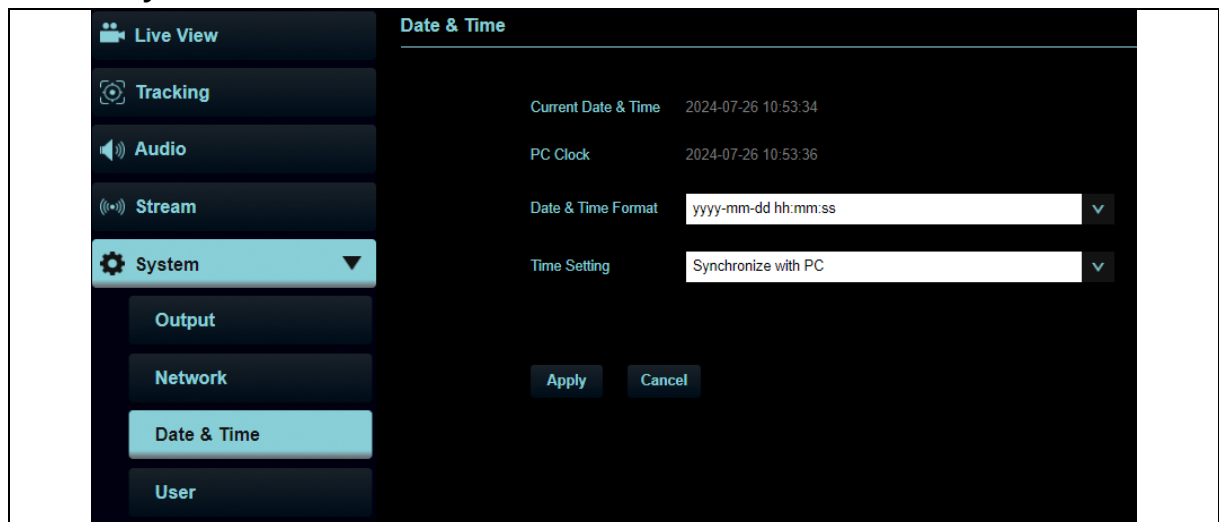

Description
Display the current camera/PC date/time, and set the display format. Manually set [Time Settings], Date & Time or synchronize with your PC.

5.2.11 System - User

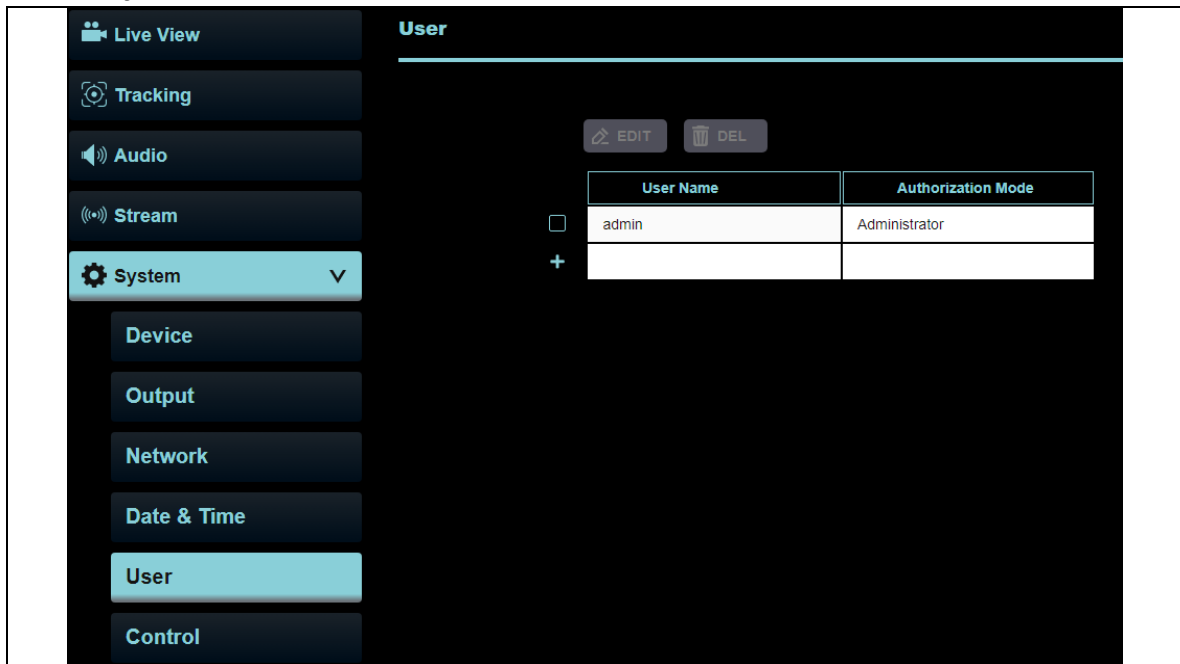

User

EDIT DEL

User Name	Authorization Mode
admin	Administrator

+

Description

Add/Modify/Delete user account

- Supports 4 - 32 characters for user name and password
- Use uppercase, lowercase letters or numbers. Special symbols cannot be used
- Account permissions:

User Type	Admin	Operator	Viewer
Live View	V	V	V
Settings	V	V	X
Account management	V	X	X

Note Performing a factory reset will clear all user data.

5.2.12 System - Control

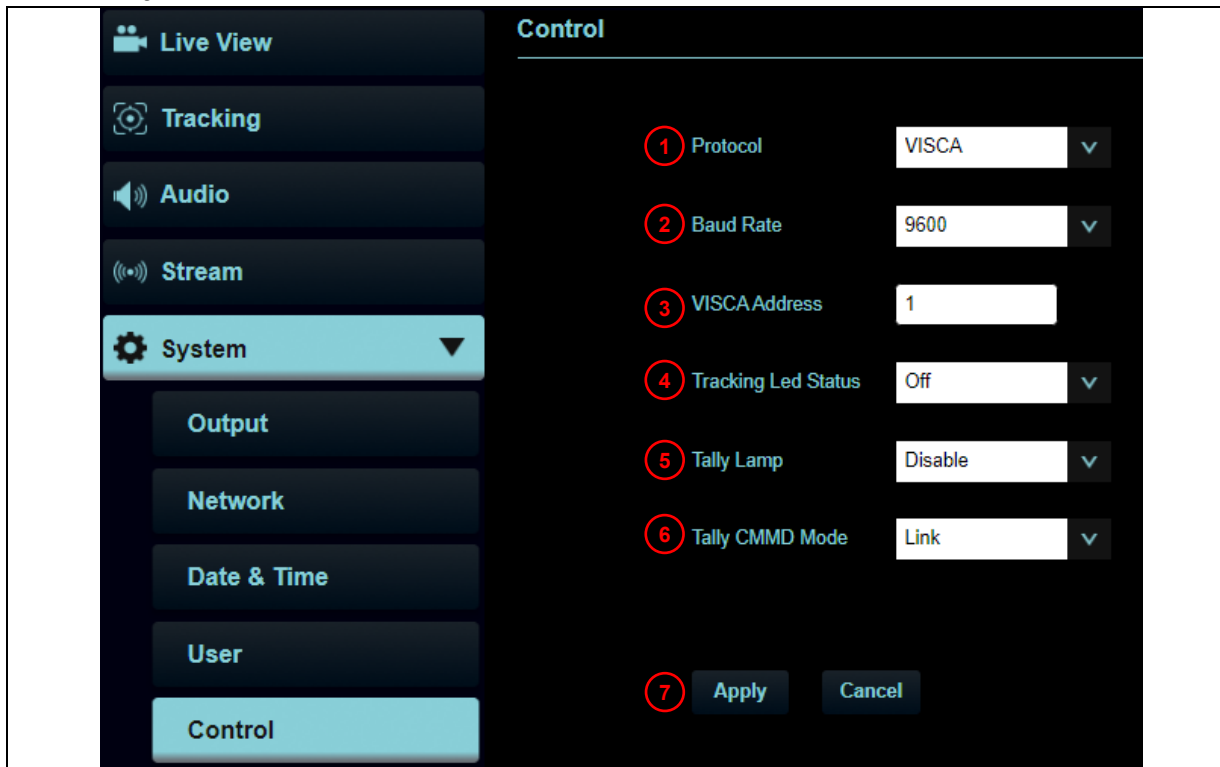

No	Item	Function Descriptions
1	Protocol	Supports VISCA protocol
2	Baud Rate	Select the transmission speed of the control signal
3	VISCA address	The camera ID address 0 ~ 7 can be assigned.
4	Tracking LED status	When enabled, LED on the front panel will flash green while the camera is tracking.
5	Tally Lamp	Enable/ disable the tally lamp.
6	Tally CMMD Mode	<p>Set whether the tally lamp is linked with RS232 commands.</p> <ul style="list-style-type: none"> ▪ Normal (Not linked): The tally lamp and mode are set separately. <ul style="list-style-type: none"> ➤ When the tally lamp is on but the default mode is off, an additional command is required to set the indicator light mode ➤ When the tally lamp is off, setting the mode will not trigger the indicator light ▪ Link: <ul style="list-style-type: none"> ➤ When the tally lamp is on, the default mode is red light ➤ When the tally lamp is off, setting the mode will turn on the tally lamp.
7	Apply/ Cancel	Apply/ Cancel Setting

5.2.13 Maintenance

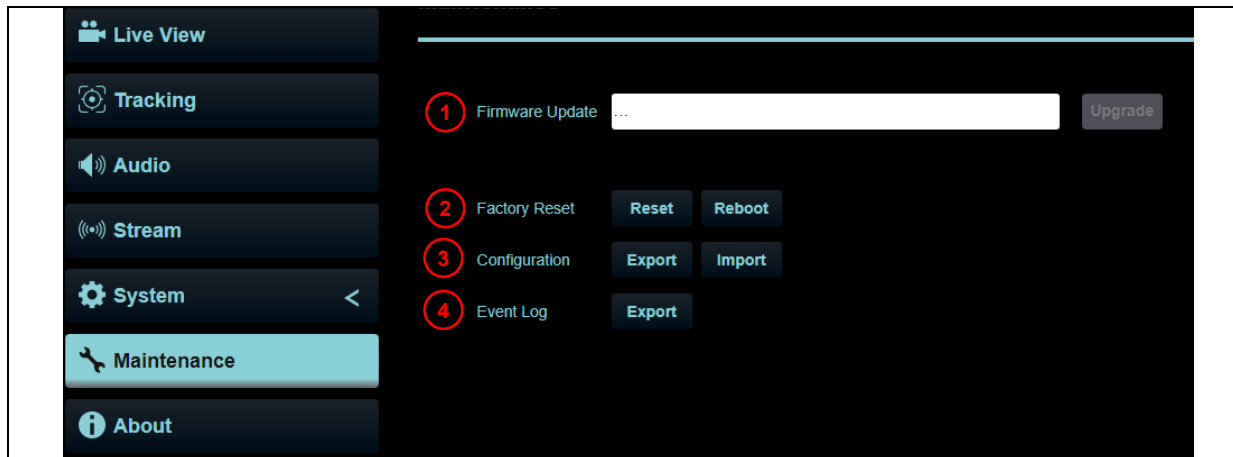

No	Item	Descriptions
1	Firmware Update	<p>Click [...] to select the firmware file, and click [Upgrade] to start updating.</p> <p>Note</p> <ul style="list-style-type: none"> Update process takes 2-3 minutes. Do not operate or turn off the power of the device during the update to avoid firmware failure.
2	Factory Reset	<ul style="list-style-type: none"> Reset: Reset all configurations to default settings. Reboot: Reboot the camera.
3	Configuration	Save setup parameters as a Profile, and users can download and upload camera setup parameters.
4	Event Log	If the camera operates abnormally, please export event log and provide it to Lumens for investigation.

5.2.14 About

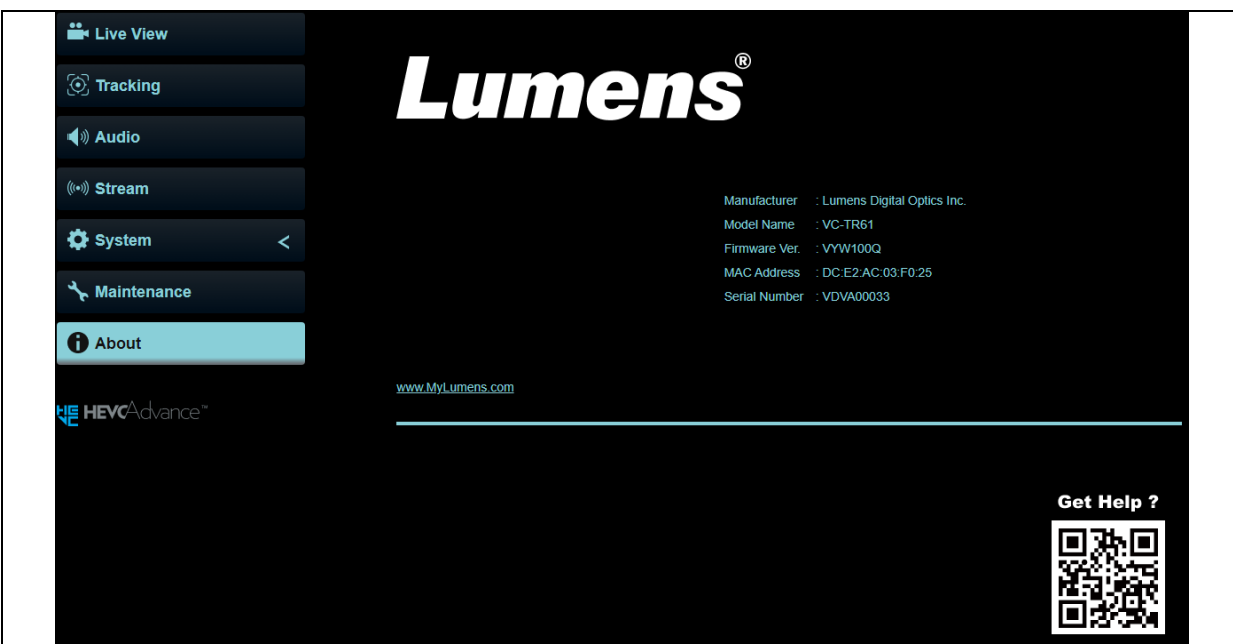

Description
<p>Display the firmware version, serial number, and other related information of the camera</p> <p>For technical support, please scan the QR code at the bottom right.</p>

Chapter 6 Troubleshooting

This chapter describes problems you may encounter while using VC-TR61. If you have questions, please refer to related chapters and follow all the suggested solutions.

If the problem still occur, please contact your local distributor or Lumens.

No.	Problems	Solutions
1.	No power to the device	<ol style="list-style-type: none"> 1. Make sure you have plugged in the power cord. 2. When using a PoE connection, ensure that the power supply supports PoE+ (IEEE802.3at).
2.	There is no image output from camera	<ol style="list-style-type: none"> 1. Check the power supply or PoE supply functions. 2. Confirm whether the camera resolution can be used with the connected display. <ul style="list-style-type: none"> ▪ If the camera is set to 4K resolution, output, confirm the display supports 4K output 3. Replace the cable and make sure it' s not faulty.
3.	Camera image is severely delayed	Use 60/50 fps rather than 25/30 fps signals.
4.	RS-232 cannot be controlled	<ol style="list-style-type: none"> 1. Confirm the connection is correct (RS-232 In/ Out) 2. Please make sure the Baud rate setting is the same as the control device.
5.	ONVIF software cannot discover the camera	Please make sure that [System]> [Device]> [Camera ID]/ [Location] in the web page uses only English letters or numbers. The ONVIF software cannot find the camera if you use special symbols or space.
6.	The camera does not save relevant parameters (PTZ, AWB ...) after reboot	<p>Please make sure if the [Initial Position] is set to [Last MEM] from the setting menu or web page</p> <ul style="list-style-type: none"> ▪ OSD Menu: [System]> [Initial Position] ▪ Web page: [Live View]> [Setting 
7.	How to log into the webpage when you forget the password	Please contact the local distributor or Lumens.

Chapter 7 Addendum

7.2 Camera Size

- Length x Width x Height: 174 x 186.65 x 197.11mm
- Weight: 2.2Kg

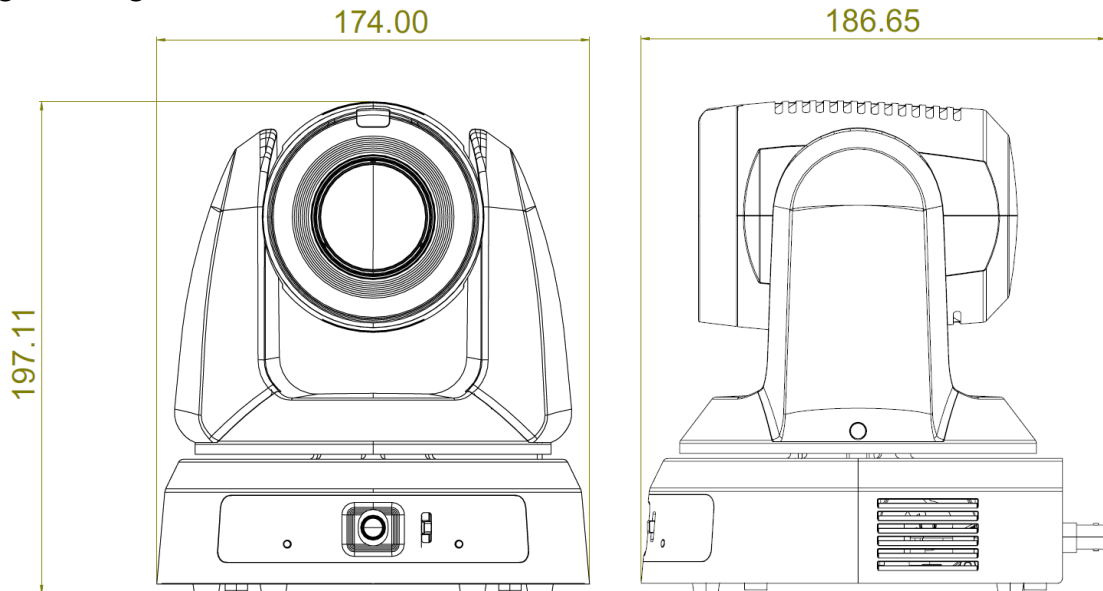

7.3 Dimensions of the base

The camera can be mounted on a 1/4" -20 UNC PTZ tripod head by using the lock holes on the bottom.

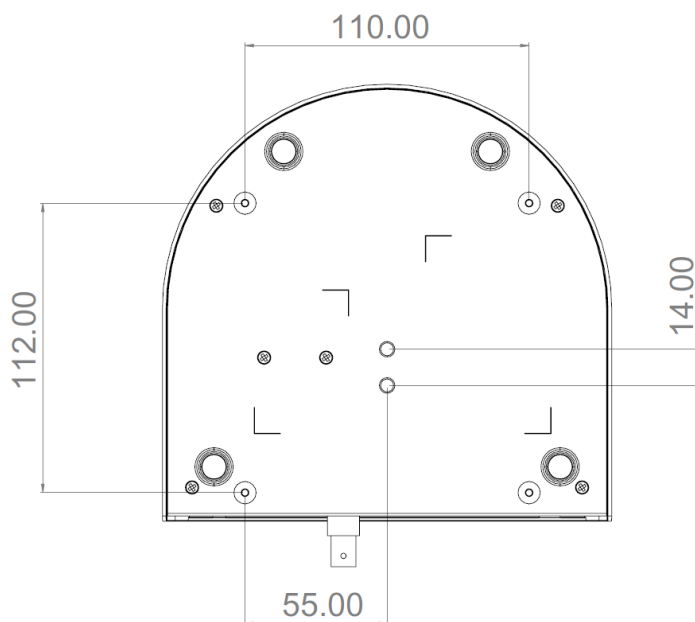

7.4 Metal Plate size diagram

(1) Metal plate A - camera side

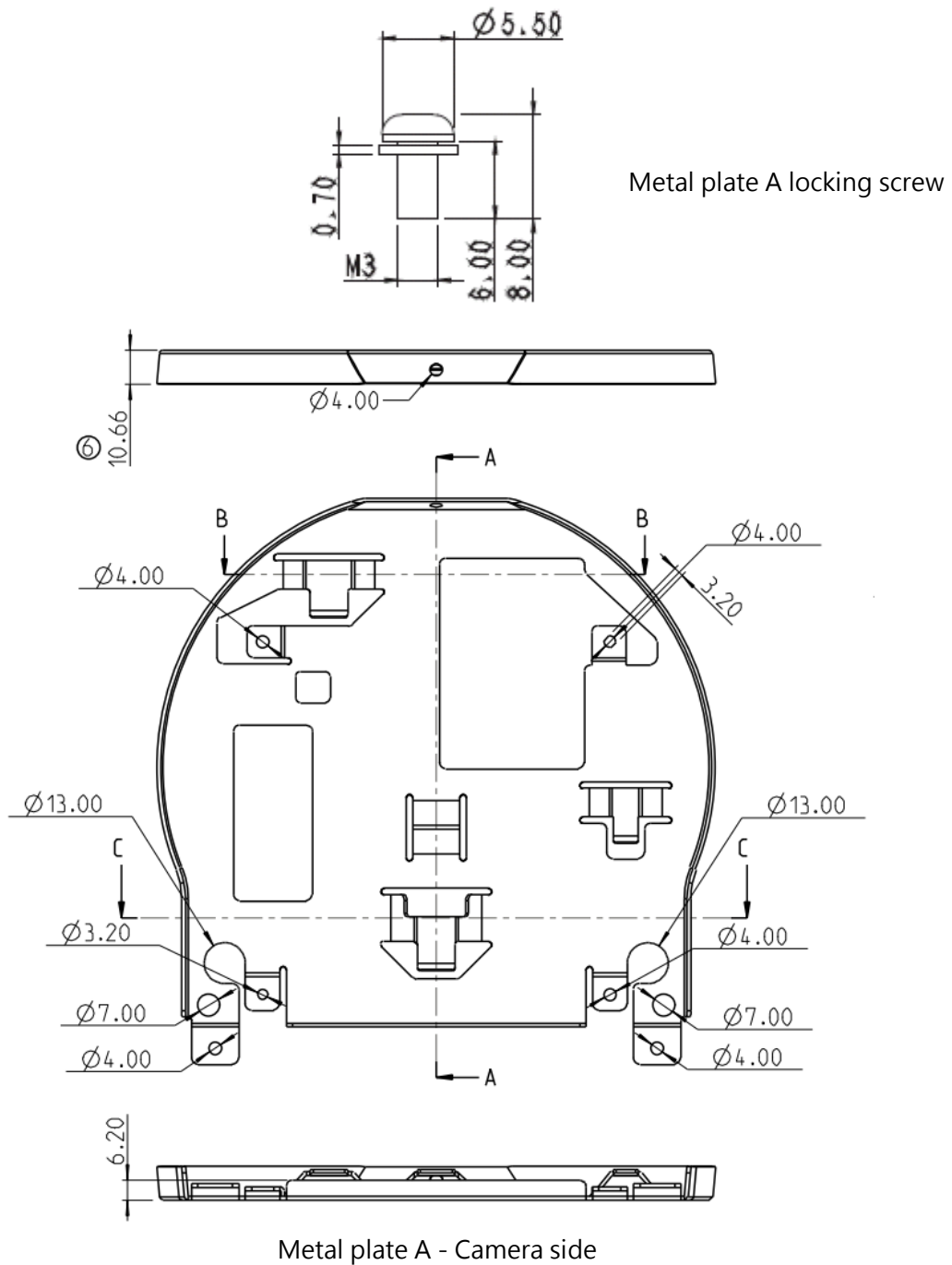

(2) Metal plate B - ceiling side

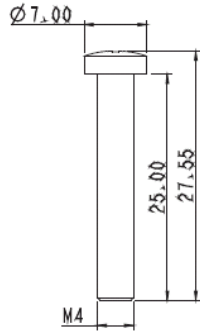

Metal plate B locking screw

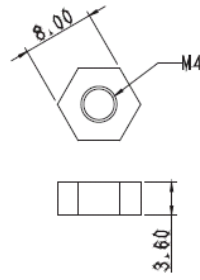

Metal plate B locking bolt

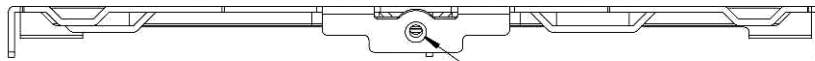

M3 threaded hole

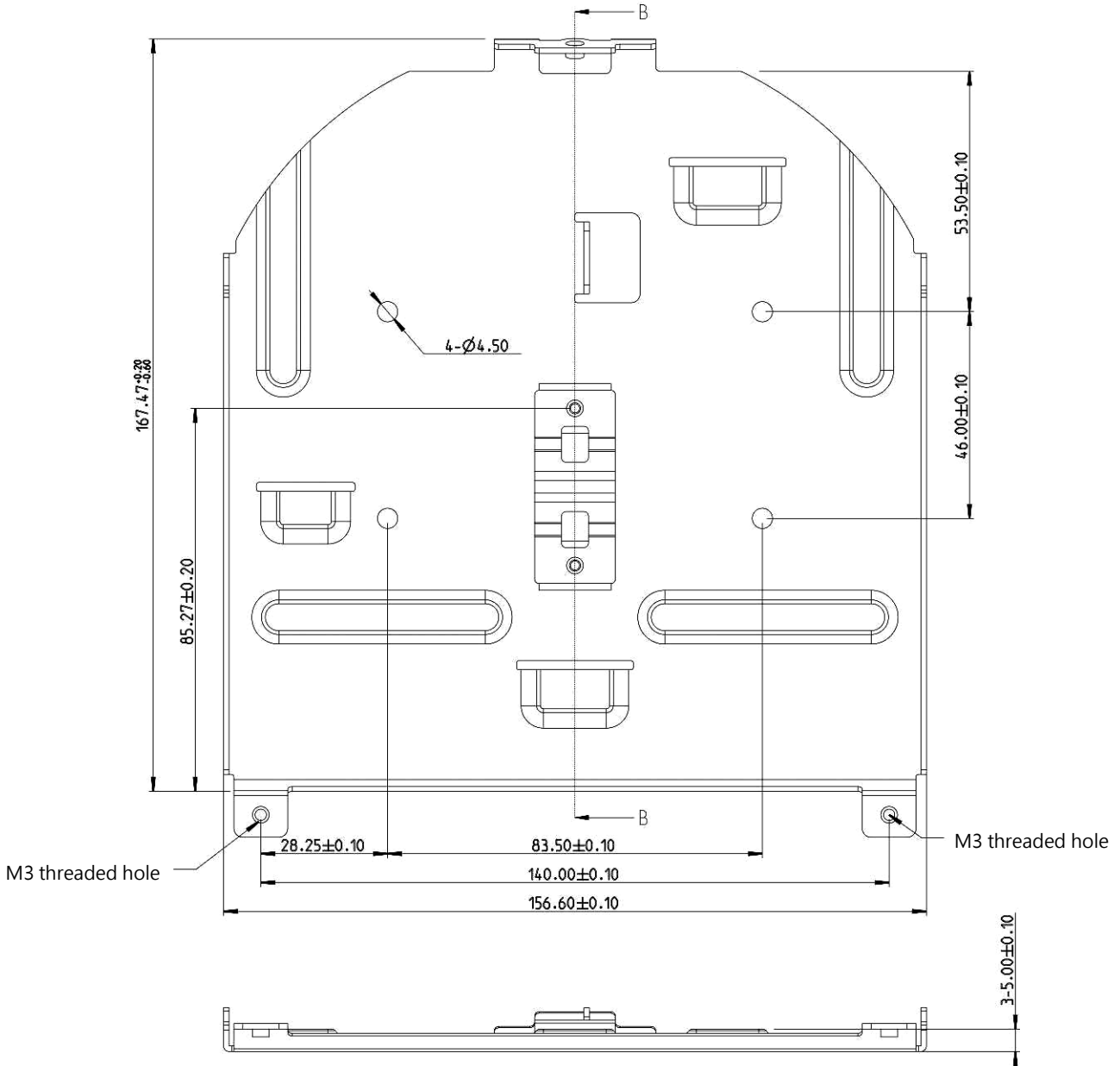

Metal plate B - ceiling side

Chapter 8 Safety Instructions

Always follow these safety instructions when setting up and using PTZ Video Camera:

1 Operation

- 1.1 Please use the product in the recommended operating environment, away from water or source of heat
- 1.2 Do not place the product on an uneven surface.
- 1.3 Ensure the power plug is free of dust prior to usage. Do not insert the product's power plug into a multiplug to avoid the risk of fire.
- 1.4 Do not block the slots and openings in the case of the product. They provide ventilation and prevent the product from overheating.
- 1.5 Do not open or remove covers. It may expose you to dangerous voltages and other hazards. Refer all servicing to licensed service personnel.
- 1.6 Unplug the product from the wall outlet and refer servicing to licensed service personnel when the following situations happen:
 - If the USB port becomes damaged or frayed.
 - If liquid is spilled into the product or the product has been exposed to rain or water.

2 Installation

- 2.1 Use a mount with UL or CE safety certifications. Only technical personnel approved by your sales agent should install the device.

2.2 Storage

- 2.3 Do not place the product where the cables can be stepped on as this may result in damage to the lead or the plug.
- 2.4 Unplug the product during thunderstorms or if it is not going to be used for an extended period.
- 2.5 Do not place the product or accessories on top of vibrating equipment or heated objects.

3 Cleaning

- 3.1 Disconnect all the cables prior to cleaning. Wipe the surface with a dry cloth. Do not use alcohol or solvents for cleaning.

4 Batteries (for products or accessories with batteries)

- 4.1 When replacing batteries, please only use the same type of batteries.
- 4.2 When disposing of batteries or products, please adhere to the relevant instructions in your country or region for disposing of batteries or products.

■ Precautions

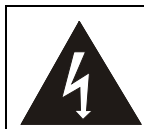

This symbol indicates that this equipment may contain dangerous voltage which could cause electric shock. Do not remove the cover (or back). No user-serviceable parts inside. Refer servicing to licensed service personnel.



This symbol indicates that there are important operating and maintenance instructions in this User Manual with this unit.

■ FCC Warning

This equipment has been tested and found to comply with the limits for a Class A digital device, pursuant to part 15 of the FCC Rules. These limits are designed to provide reasonable protection against harmful interference when the equipment is operated in a commercial environment.

Notice :

The changes or modifications not expressly approved by the party responsible for compliance could void the user's authority to operate the equipment.

This equipment has been tested and found to comply with the limits for a Class A digital device, pursuant to part 15 of the FCC Rules. These limits are designed to provide reasonable protection against harmful interference when the equipment is operated in a commercial environment.

■ **IC Warning**

This digital apparatus does not exceed the Class A limits for radio noise emissions from digital apparatus as set out in the interference-causing equipment standard entitled “Digital Apparatus,” ICES-003 of Industry Canada.

Cet appareil numérique respecte les limites de bruits radioélectriques applicables aux appareils numériques de Classe A prescrites dans la norme sur le matériel brouilleur: “Appareils Numériques,” NMB-003 édictée par l'Industrie.

■ **EN55032 CE Warning**

Operation of this equipment in a residential environment could cause radio interference.

Warning: Operation of this equipment in a residential environment may cause radio interference

Copyright Information

Copyrights © Lumens Digital Optics Inc. All rights reserved.

Lumens is a trademark registered by Lumens Digital Optics Inc.

Copying, reproducing or transmitting this file is not allowed if a license is not provided by Lumens Digital Optics Inc. unless copying this file is for the purpose of backup after purchasing this product.

In order to keep improving the product, the information in this file is subject to change without prior notice.

To fully explain or describe how this product should be used, this manual may refer to names of other products or companies without any intention of infringement.

Disclaimer of warranties: Lumens Digital Optics Inc. is neither responsible for any possible technological, editorial errors or omissions, nor responsible for any incidental or related damages arising from providing this file, using, or operating this product.