



VE2812AUST / VE2812AEUT
HDMI & VGA HDBaseT Transmitter
with US / EU Wall Plate
User Manual



EMC Information

FEDERAL COMMUNICATIONS COMMISSION INTERFERENCE

STATEMENT: This equipment has been tested and found to comply with the limits for a Class A digital device, pursuant to Part 15 of the FCC Rules. These limits are designed to provide reasonable protection against harmful interference when the equipment is operated in a commercial environment. This equipment generates, uses, and can radiate radio frequency energy and, if not installed and used in accordance with the instruction manual, may cause harmful interference to radio communications. Operation of this equipment in a residential area is likely to cause harmful interference in which case the user will be required to correct the interference at his own expense.

FCC Caution: Any changes or modifications not expressly approved by the party responsible for compliance could void the user's authority to operate this equipment.

Warning: Operation of this equipment in a residential environment could cause radio interference.

This device complies with Part 15 of the FCC Rules. Operation is subject to the following two conditions:

- (1) this device may not cause harmful interference, and
- (2) this device must accept any interference received, including interference that may cause undesired operation.

Suggestion: Shielded twisted pair (STP) cables must be used with the unit to ensure compliance with FCC & CE standards.

KCC Statement

유선 제품용 / A 급 기기 (업무용 방송 통신 기기)
이 기기는 업무용 (A 급) 전자파적합기기로서 판매자 또는 사용자는 이 점을 주의하시기 바라며, 가정 외의 지역에서 사용하는 것을 목적으로 합니다.

RoHS

This product is RoHS compliant.



User Information

Online Registration

Be sure to register your product at our online support center:

International	http://eservice.aten.com
---------------	---

Telephone Support

For telephone support, call this number:

International	886-2-8692-6959
China	86-400-810-0-810
Japan	81-3-5615-5811
Korea	82-2-467-6789
North America	1-888-999-ATEN ext 4988 1-949-428-1111

User Notice

All information, documentation, and specifications contained in this manual are subject to change without prior notification by the manufacturer. The manufacturer makes no representations or warranties, either expressed or implied, with respect to the contents hereof and specifically disclaims any warranties as to merchantability or fitness for any particular purpose. Any of the manufacturer's software described in this manual is sold or licensed as *is*. Should the programs prove defective following their purchase, the buyer (and not the manufacturer, its distributor, or its dealer), assumes the entire cost of all necessary servicing, repair and any incidental or consequential damages resulting from any defect in the software.

The manufacturer of this system is not responsible for any radio and/or TV interference caused by unauthorized modifications to this device. It is the responsibility of the user to correct such interference.

The manufacturer is not responsible for any damage incurred in the operation of this system if the correct operational voltage setting was not selected prior to operation. PLEASE VERIFY THAT THE VOLTAGE SETTING IS CORRECT BEFORE USE.

Package Contents

- 1 VE2812AUST / VE2812AEUT HDMI & VGA HDBaseT Transmitter
- 1 3-Pin RS-232 Terminal Block
- 1 2-Pin Power Terminal Block
- 1 Mounting Kit (VE2812AEUT only)
- 1 Faceplate (VE2812AUST only)
- 1 Power Adapter
- 1 User Instructions*

Note: Make sure that all of the components are present and in good order. If anything is missing or was damaged in shipping, contact your dealer.

Table of Contents

EMC Information	ii
RoHS	ii
User Information	iii
Online Registration	iii
Telephone Support	iii
User Notice	iii
Package Contents	iv
About this Manual	vii
Conventions	viii
Product Information	ix
1. Introduction	
Overview	1
Features	2
Planning the Installation	3
Requirements	3
Considerations	3
Compatible ATEN Video Extenders	3
Components	4
Top View	4
Side View 1	5
Side View 2	5
LED Display	6
2. Hardware Setup	
Mounting the VE2812AUST / VE2812AEUT Unit	7
Site Preparation	7
VE2812AUST	7
VE2812AEUT	8
Drawing Screw Site	8
VE2812AUST	9
VE2812AEUT	9
VE2812AUST Wall Mount	10
VE2812AEUT Wall Mount	11
Connecting the VE2812AUST / VE2812AEUT Unit	12
Terminal Block Connection	13
Power Supply Information	13
RS-232 Channel Transmission	14
3. Operation	
Selecting the Input Mode	15
Input Modes	15
Input Selection Pushbutton	16

RS-232 Serial Transmission	17
Bypass	18
Command	18
Long Reach Mode	19

Appendix

Safety Instructions	21
General	21
Technical Support	23
International	23
North America	23
Specifications	24
Supported VGA Resolutions	26
Limited Warranty	27
Template Printing	28

About this Manual

This user manual is provided to help you get the most from the VE2812AUST / VE2812AEUT unit. It covers all aspects of installation, configuration, and operation. An overview of the information found in the manual is provided below.

Chapter 1, Introduction introduces you to the HDMI & VGA HDBaseT Transmitter. Its purpose, features, installation considerations, and panel components are presented and described.

Chapter 2, Hardware Setup describes the steps that are necessary to quickly and safely set up your installation.

Chapter 3, Operation explains the Long Reach Mode and limitations, and how to set up the input detection mode using the a pushbutton and RS-232 commands.

Appendix provides a list of safety instructions and precautions, contact information for ATEN technical support, product specifications, and other technical information.

Note:

- ◆ Read this manual thoroughly and follow the installation and operation procedures carefully to prevent any damage to the unit or any connected devices.
 - ◆ ATEN regularly updates its product documentation for new features and fixes. For an up-to-date VE2812AUST / VE2812AEUT documentation, visit <http://www.aten.com/global/en/>
-

Conventions

This manual uses the following conventions:

- | | |
|---|--|
| Monospaced | Indicates text that you should key in. |
| [] | Indicates keys you should press. For example, [Enter] means to press the Enter key. If keys need to be chorded, they appear together in the same bracket with a plus sign between them: [Ctrl+Alt]. |
| 1. | Numbered lists represent procedures with sequential steps. |
| ◆ | Bullet lists provide information, but do not involve sequential steps. |
| → | Indicates selecting the option (on a menu or dialog box, for example), that comes next. For example, Start → Run means to open the <i>Start</i> menu, and then select <i>Run</i> . |
|  | Indicates critical information. |

Product Information

For information about all ATEN products and how they can help you connect without limits, visit ATEN on the Web or contact an ATEN Authorized Reseller. Visit ATEN on the Web for a list of locations and telephone numbers:

International	http://www.aten.com
North America	http://www.aten-usa.com

This Page Intentionally Left Blank

Chapter 1

Introduction

Overview

ATEN VE2812AUST / VE2812AEUT is a video transmitter that can send VGA (with audio) and HDMI signals up to 100 m over a single Cat 5e/6/6a or ATEN 2L-2910 Cat 6 cable. Featuring built-in PoH (Power over HDBaseT) function, the VE2812AUST / VE2812AEUT receives power supply from the HDBaseT output port on the connected device. This eliminates the need for a power adapter and reduces the hassle of power line deployment behind the wall.

The VE2812AUST / VE2812AEUT guarantees reliable transmission of HDMI/ VGA signals. For HDMI signal transmission, it supports 3D, Deep Color, and embedded HD lossless audio formats. In addition, the VE2812AUST / VE2812AEUT supports Long Reach Mode, which allows the device to transmit signals up to 150 m, 1080p, over a Cat 5e/6 cable.

For utility flexibility, the VE2812AUST / VE2812AEUT can serve as a video switch by connecting to two sources and distribute them to an identical output. The compact wall plate design does away with bulky cables, allowing a neat and convenient installation in the wall or the table. The VE2812AUST / VE2812AEUT is designed for use in meeting rooms or digital education environments where high video quality is required.

Features

- ◆ Extends HDMI or VGA signals over a single Cat 5e/6/6a or ATEN 2L-2910 Cat 6 cable
- ◆ HDMI 1.4 (3D, Deep Color, 4K); HDCP 2.2 compliant
- ◆ Superior video quality
 - ◆ HDMI 4K up to 100 m via a Cat 5e/6/6a cable or ATEN 2L-2910 Cat 6 cable
 - ◆ VGA 1600 x 1200 / 1920 x 1200 up to 100 m via a Cat 5e/6/6a or ATEN 2L-2910 Cat 6 cable
- ◆ Supports HDBaseT Long Reach Mode – extends signals up to 150 m, 1080p via a single Cat 5e/6 cable
- ◆ Built-in PoH (Power over HDBaseT) function – the VE2812AUST / VE2812AEUT receives power supply from the HDBaseT output port on the connected device
- ◆ Supports Auto Switch – the VE2812AUST / VE2812AEUT automatically switches to a newly plugged-in source
- ◆ Functions as a switch and a converter
 - ◆ A switch: Connects to two source devices (HDMI or VGA)
 - ◆ A converter: Applies to receivers with different interfaces (DVI, DisplayPort, or HDMI)
- ◆ Supports RS-232 channel transmission and source switch control
- ◆ Compatible receivers – VE2812R, VE1812R, VE812R, VE814AR, VE811R, VE801R, VE802R, VE601R, VE901R, or future ATEN HDBaseT Receivers
- ◆ Supports IR signal frequencies from 30 kHz to 60 kHz
- ◆ Plug-and-play with no required software
- ◆ LED indication of sources and device status

Planning the Installation

Requirements

Prepare the following before installing the VE2812AUST / VE2812AEUT unit:

- ◆ 1 HDMI and/or VGA source device
- ◆ 1 Cat 5e/6/6a or ATEN 2L-2910 Cat 6 cable

Considerations

- ◆ To ensure video quality, ATEN recommends using a Cat 5e/6/6a cable.

Note: ATEN recommends using the ATEN 2L-2910 Cat 6 cable for best results.

- ◆ The maximum transmission distance varies at different parts of the transmission:

Connection	Interface	Distance
Computer to the VE2812AUST / VE2812AEUT	HDMI / VGA	1.8 m
The VE2812AUST / VE2812AEUT to a compatible ATEN Video Extender	Cat 5e/6/6a	100 m / 150 m (up to 1080p in Long Reach Mode)
A compatible ATEN Video Extender to the display	HDMI (example)	5 m

Note: The maximum transmission distance for 4K resolution using a Cat 5e cable is 70 m.

Compatible ATEN Video Extenders

The VE2812AUST / VE2812AEUT is compatible with a wide range of ATEN HDBaseT video extenders. Visit our official web site for more details.

Components

Top View

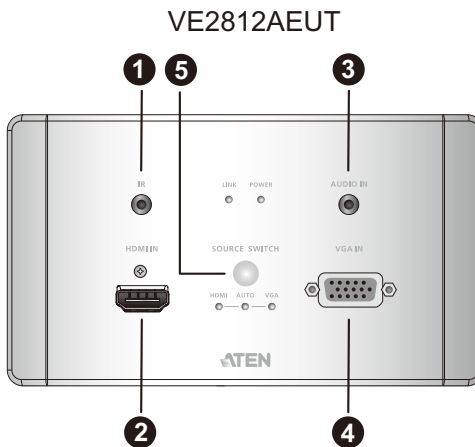
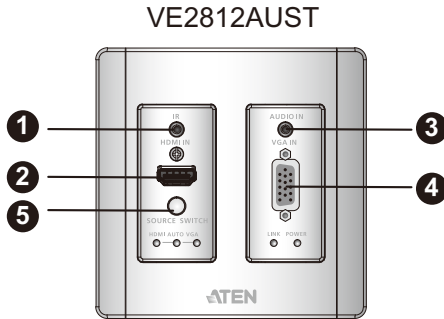

No.	Component	Description
1	IR Port	Connects to an IR transmitter/receiver.
2	HDMI Input Port	Connects to the HDMI Out port on the source device.
3	Audio Input Port	Connects to the Audio Out port on the source device.
4	VGA Input Port	Connects to the VGA Out port on the source device.
5	Source Switch Pushbutton	Press to switch among the Auto Switch, HDMI, and VGA input mode. The input mode status is indicated by the three LEDs to the right of this pushbutton. For details, see <i>LED Display</i> , page 6.

Side View 1

VE2812AUST

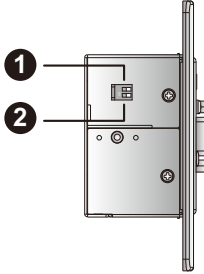

VE2812AEUT

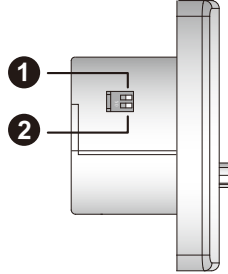

No.	Component	Description
1	Firmware Upgrade Switch	This port is reserved for ATEN Technical Support. If you would like to do a firmware upgrade yourself, please contact your dealer.
2	HDBaseT Long Reach Mode Switch	Put the switch to ON to enable the Long Reach Mode. For more details on Long Reach Mode, see <i>Long Reach Mode</i> , page 19.

Side View 2

VE2812AUST

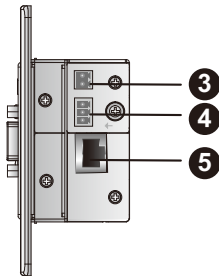

VE2812AEUT

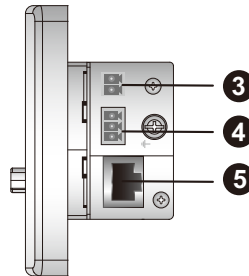

No.	Component	Description
3	Power Jack	Connects to the Power Adapter.
4	RS-232 Serial Port	Connects to an RS-232 main controller, such as a PC or Control system.
5	HDBaseT Output	Connects to the HDBaseT Input port on a compatible ATEN video receiver via an RJ-45 cable.

LED Display

You can find the unit's LEDs on the top and front panel as illustrated below. See the table below for details on LED indication.

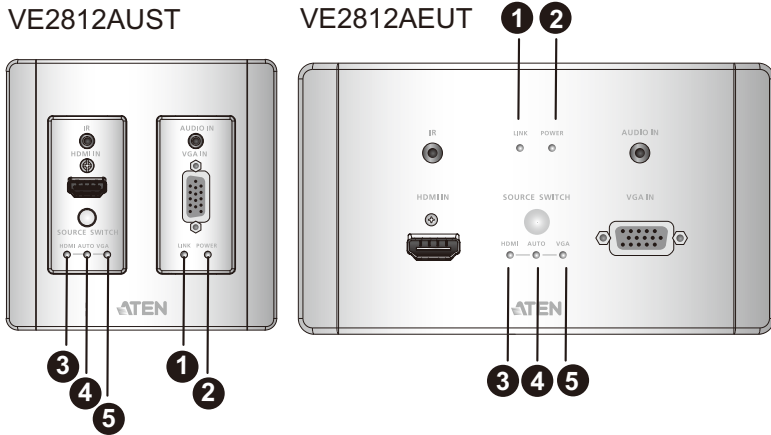

No.	LED	Indication	Description
1	Link LED	Lights orange	The transmission to the receiver is stable.
		Blinks orange	The transmission to the receiver is unstable.
2	Power LED	Lights green	The unit is receiving power.
3	HDMI Mode LED	Lights orange	The unit is set to transmit HDMI input.
4	Auto Switch Mode LED	Lights orange	The unit is in the Auto Switch mode. For details, see <i>Selecting the Input Mode</i> , page 15.
5	VGA Mode LED	Lights orange	The unit is set to transmit VGA input.

Note:

- ◆ The Power and Link LED blink at the same time to indicate that the firmware upgrade is in progress.
- ◆ Auto Switch Mode LED, HDMI Mode LED, and VGA Mode LED light and blink at the same time to indicate that the RS-232 mode is changed.

Chapter 2

Hardware Setup



1. Please review the safety information regarding the placement of this device in *Safety Instructions*, page 21.
2. Do not power on the VE2812AUST / VE2812AEUT until all the necessary hardware is connected.

Mounting the VE2812AUST / VE2812AEUT Unit

VE2812AUST / VE2812AEUT is designed to be installed in a wall or ceiling.

Site Preparation

Choose a location where cables are free of interference and install the cables into the wall before installing the unit.

The unit can be installed into a wall box or simply into a recession in the wall. Please reserve enough space in the site for the body of the unit.

The recommended reserved space for each unit is shown below:

VE2812AUST

Depth (into the wall): 42mm

Length x Width: 98.4mm x 95mm

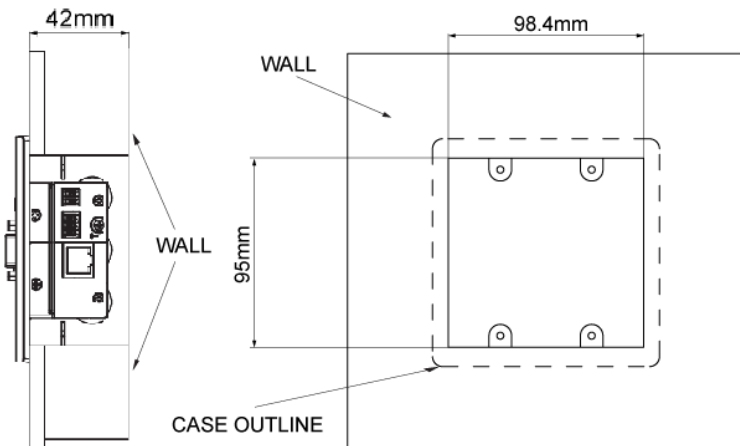

VE2812AEUT

Depth (into the wall): 35.5mm

Length x Width: 111mm x 52.5mm

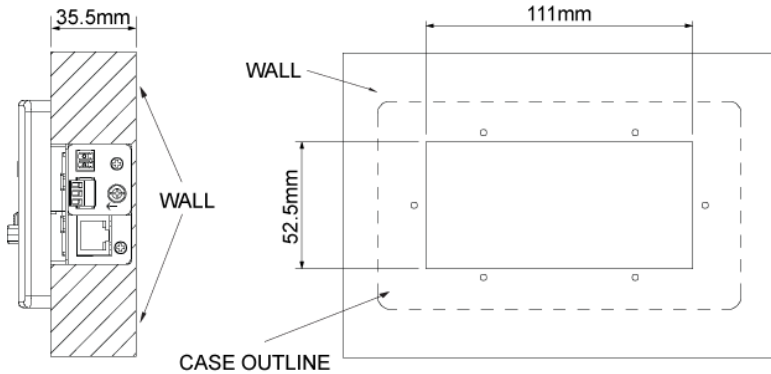

Drawing Screw Site

Screw sites are required to secure the unit into the wall. There are regional template screw sites and the unit can use the sites easily.

If you wish to create your own installation sites, the dimensions below will help you decide how to draw them.

Template is available at the end of the document for both models, please refer to *Template Printing* on page 28 for more details.

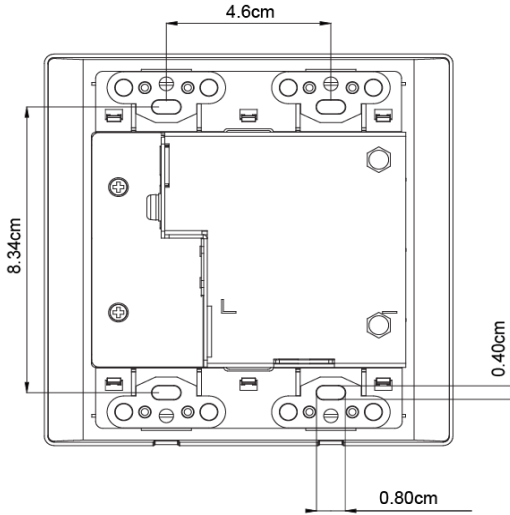
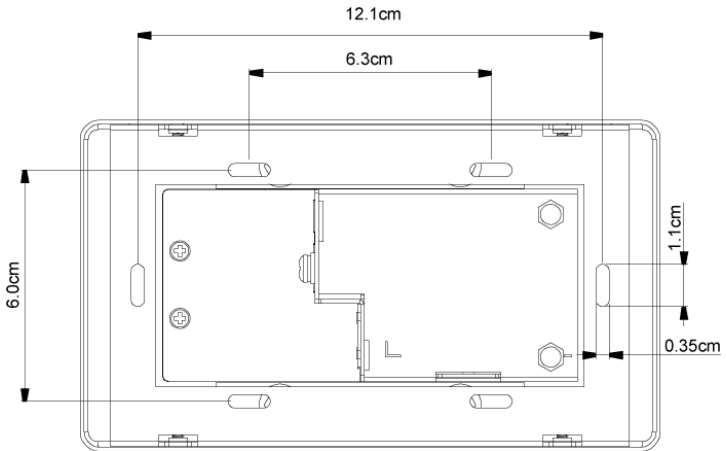
VE2812AUST**VE2812AEUT**

VE2812AUST Wall Mount

1. Insert the VE2812AUST / VE2812AUST2 to your installation site and secure it by tightening 4 screws to the screw holes. This installation site can be a wall or ceiling.

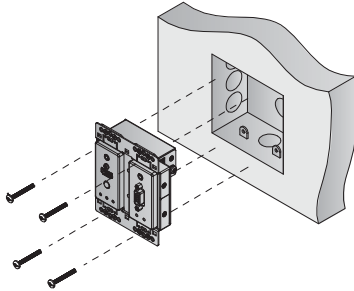

Note: Screws stabilizing the unit to the site are not included in the package content

2. Attach the hook on the top of the faceplate to the VE2812AUST / VE2812AUST2 until it clicks in place.

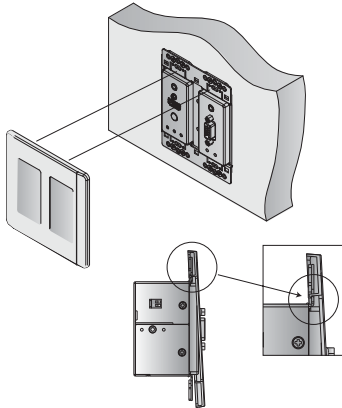

3. Push in the lower part of the faceplate on the VE2812AUST / VE2812AUST2 until it clicks in place.

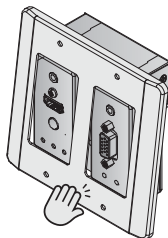

VE2812AEUT Wall Mount

1. Secure the supplied mounting kit to your installation site by tightening 4 screws (EU type) or 2 screws (MK type) to the screw holes. This installation site can be a wall or ceiling.

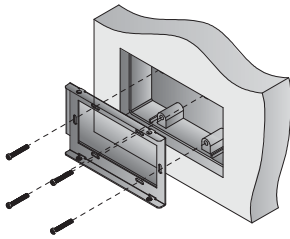

For EU Type

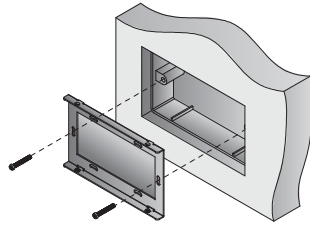

For MK Type

Note: Screws stabilizing the mounting kit are not included in the package content.

2. Insert the VE2812AEUT to the installation site and secure it by tightening the 4 screws onto the mounting kit.

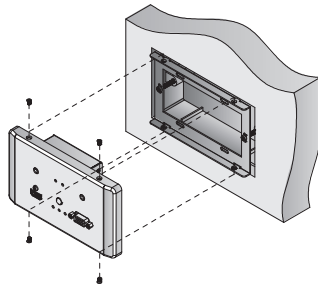

Note: Screws stabilizing the unit to the site are not included in the package content.

Connecting the VE2812AUST / VE2812AEUT Unit

Follow the steps below to connect the VE2812AUST / VE2812AEUT to a source, a compatible ATEN Video Extender, and other controls as required.

VE2812AUST

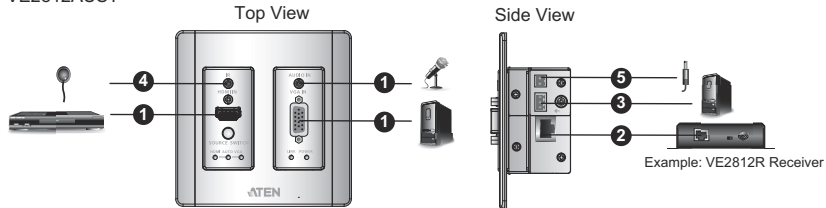

VE2812AEUT

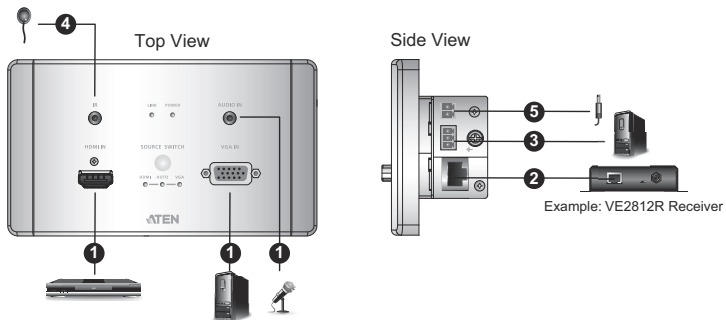

1. Use an HDMI or VGA cable to connect the HDMI or VGA output port on your source device to the HDMI or VGA Input Port.

Note: For a VGA source, make sure to also connect a VGA audio jack to the Audio In port on the VE2812AUST / VE2812AEUT unit to transmit audio.

2. With the built-in PoH PD capability, the VE2812AUST / VE2812AEUT can be powered on through an Ethernet cable. Connect one end of the RJ-45 cable to the HDBaseT Output port on the VE2812AUST / VE2812AEUT, and the other end to the HDBaseT Input port on your video extender receiver.

Note: The example VE2812R used in the above diagram is not PoH compatible. VE2812R cannot supply power to the VE2812AUST / VE2812AEUT through Ethernet cable.

- (Optional) Connect your computer or control system to the RS-232 Serial Port on the VE2812AUST / VE2812AEUT.

Note: The RS-232 Serial Port is a terminal block connector. Please refer to *Terminal Block Connection* on page 13 for more details.

- (Optional) Connect an IR transmitter/receiver to the IR port.
- (Optional) Plug the Power Adapter cable into the Power Terminal Block on the VE2812AUST / VE2812AEUT to power on the device. Please refer to *Power Supply Information* on page 13 for more details.

Note: The VE2812AUST / VE2812AEUT prioritizes the power supply from the power adapter when the Power Adapter is plugged in.

Terminal Block Connection

Follow the instructions below for terminal block connection:

- Detach the terminal block from the port (e.g. RS-232 Serial Port).
- Loosen the screws on top of the terminal block (turning a screwdriver counter-clockwise) to open the gates.
- Insert the wires into the gates according to the label on the unit.
- Tighten the screws for each gate to secure the wires to the terminal block.
- Attach the terminal block back to its port.

Power Supply Information

Follow the diagram and the steps below to connect the power to the unit.

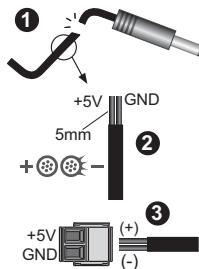

- Cut the connector end of the power adapter.
- Strip 5mm (0.5cm) off the insulation cover of the Power Adapter cable to expose two wires: a +5V wire and a GND (grounding) wire.

3. Insert the exposed +5V wire and GND wire tightly into the provided 2-pin Terminal Block Connector. Refer to *Terminal Block Connection* on page 13 for more details.

Note: You can determine the exposed wire's polarity (i.e., +5V or GND) by using a voltmeter.

RS-232 Channel Transmission

You can manage the VE2812AUST / VE2812AEUT via RS-232 serial devices, such as computers or bar code scanners. The RS-232 signal transmission flow can be illustrated as follows (VE2812UST is used as the example):

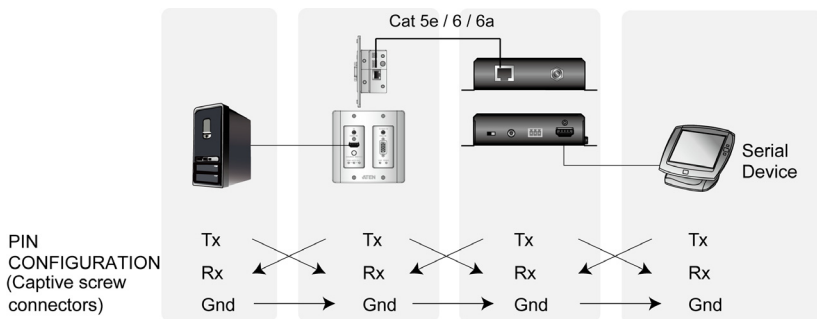

The general concept here is that a RS-232 signal can be transmitted (Tx) to the receiving (Rx) end of a unit. The received signal can then be transmitted (Tx) to the receiving (Rx) end of another unit. The RS-232 signals can be transmitted back the other way.

You can set the VE2812AUST / VE2812AEUT to either bypass serial data or to receive RS-232 commands. By default, the VE2812AUST / VE2812AEUT is set to receive serial data. To set the unit to bypass RS-232 commands, press the Input Switch pushbutton for 3 seconds. For details on RS-232 commands, see *RS-232 Serial Transmission*, page 17.

Chapter 3

Operation

Selecting the Input Mode

Input Modes

You can switch among different input modes based on your needs. Refer to the table below for how each mode works.

Input Mode	Description
Auto Switch (Default / LED lights orange)	<p>The VE2812AUST / VE2812AEUT:</p> <ul style="list-style-type: none">◆ Before power on, the VE2812AUST / VE2812AEUT prioritizes HDMI transmission if both HDMI Input and VGA Input ports are connected.◆ After powered on, the VE2812AUST / VE2812AEUT prioritizes the latest detected input source transmission to the connected receiver. * <p>Note: You can disable this part of the Auto Switch mode (automatic input switching) using an RS-232 command. For more details, see <i>RS-232 Serial Transmission</i>, page 17.</p>
HDMI (LED lights orange)	The VE2812AUST / VE2812AEUT only transmits HDMI source to the connected receiver.
VGA (LED lights orange)	The VE2812AUST / VE2812AEUT only transmits VGA source and its audio input to the connected receiver.

Input Selection Pushbutton

Press the **Input Switch Pushbutton** located on the front panel to switch among the Auto Switch, HDMI, and VGA input mode.

VE2812AUST

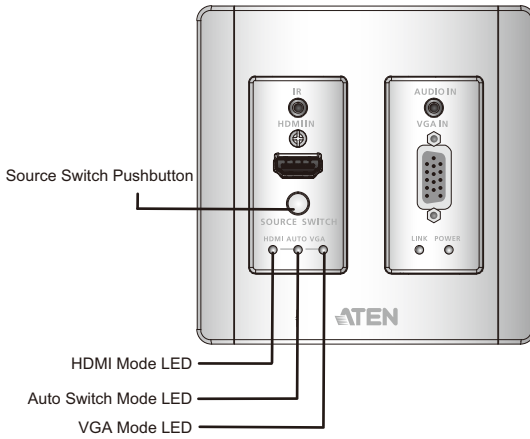

VE2812AEUT

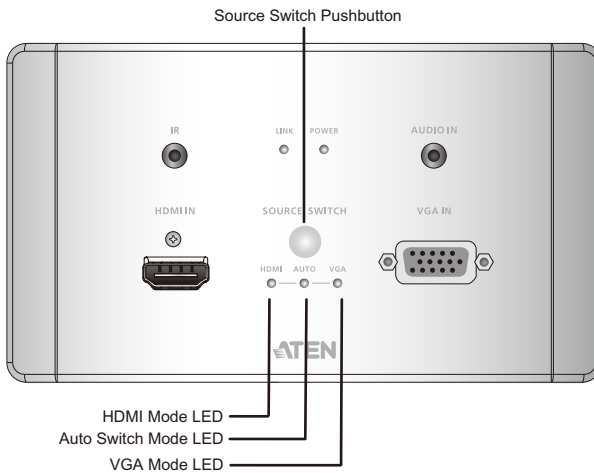

RS-232 Serial Transmission

The RS-232 Serial Transmission allows you to choose whether to bypass serial data or to remotely control the VE2812AUST / VE2812AEUT using commands depending on your installation.

To switch the VE2812AUST / VE2812AEUT RS-232 mode, do the following:

1. Press the Source Switch Pushbutton for 3 seconds as shown in the diagram below.

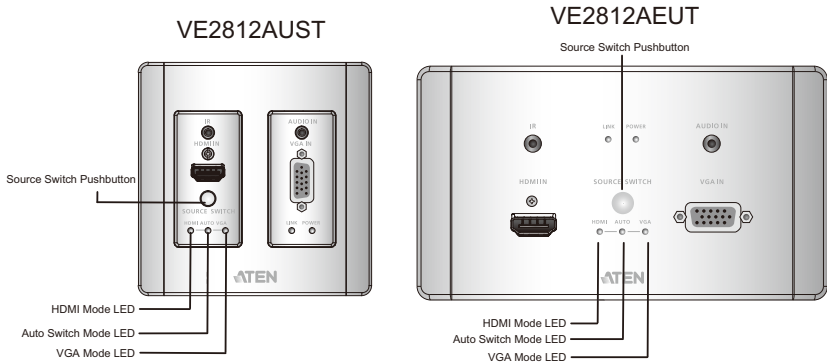

- ◆ Bypass mode: the Auto LED, HDMI LED, and VGA LED light orange and blink once per second for three seconds.
- ◆ **Command mode:** the Auto LED, HDMI LED, and VGA LED light orange and blink once every 0.3 seconds for three seconds.

Note: 1. By default, the VE2812AUST / VE2812AEUT is set to **Command mode**.

2. The RS-232 status is kept even VE2812AUST / VE2812AEUT is powered on and off. For detailed LEDs behavior, see *LED Display*, page 6.

Bypass

RE-232 serial data is bypassed from the controller PC or Pad to other connected devices.

Command

You can change the input mode using RS-232 commands. Refer to the table below for a list of available tasks and the corresponding commands.

Type the corresponding command to execute a task. For example, to enable automatic switching, type **swmode next** and then press **[Enter]**.

Task	Command		
	Control	Input	Port
Enable automatic input switching	swmode plugin auto	N/A	N/A
Disable automatic input switching	swmode plugin off	N/A	N/A
Enable automatic plug-out switching	swmode plugin off	N/A	N/A
Disable automatic plug-out switching	swmode plugin auto	N/A	N/A
Set the unit to the HDMI mode	sw	i	01
Set the unit to the VGA mode	sw	i	02
View the current input mode settings	read	N/A	N/A

Note:

- ◆ Press **[Enter]** to execute a command.
 - ◆ The current input mode setting is also indicated by the Auto Switch, HDMI, and VGA LEDs.
 - ◆ The automatic plug-out switching is enabled by default.
-

Long Reach Mode

Long Reach Mode is a modulation that extends the transmission distance up to 150 m using a Cat 5e/6 cable while compromising the maximum frame rate to 1080p, 24 bpp, 60 Hz via a single Cat 5e/6 cable. To enable Long Reach Mode, put the HDBaseT Long Reach Mode Switch to **ON** at either the transmitter or the connected receiver.

VE2812AUST Side

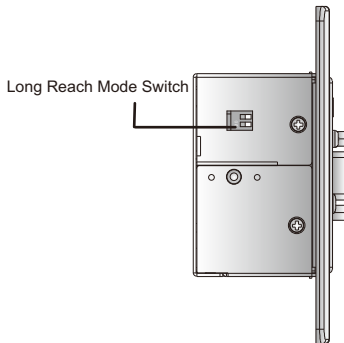

VE2812AEUT Side

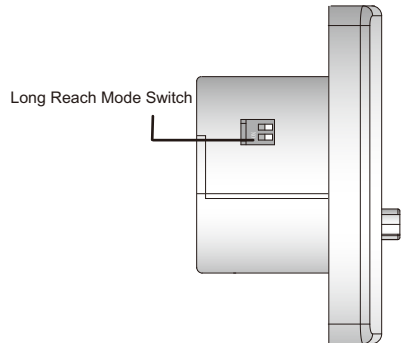

Note: When Long Reach Mode is enabled, the VE2812AUST / VE2812AEUT will not be able to transmit 4K signals, in which case, the output display will be blank.

This Page Intentionally Left Blank

Safety Instructions

General

- ◆ This product is for indoor use only.
- ◆ Read all of these instructions. Save them for future reference.
- ◆ Follow all warnings and instructions marked on the device.
- ◆ Do not place the device on any unstable surface (cart, stand, table, etc.). If the device falls, serious damage will result.
- ◆ Do not use the device near water.
- ◆ Do not place the device near, or over, radiators or heat registers.
- ◆ The device cabinet is provided with slots and openings to allow for adequate ventilation. To ensure reliable operation, and to protect against overheating, these openings must never be blocked or covered.
- ◆ The device should never be placed on a soft surface (bed, sofa, rug, etc.) as this will block its ventilation openings. Likewise, the device should not be placed in a built in enclosure unless adequate ventilation has been provided.
- ◆ Never spill liquid of any kind on the device.
- ◆ Unplug the device from the wall outlet before cleaning. Do not use liquid or aerosol cleaners. Use a damp cloth for cleaning.
- ◆ The device should be operated from the type of power source indicated on the marking label. If you are not sure of the type of power available, consult your dealer or local power company.
- ◆ The device is designed for IT power distribution systems with 230V phase-to-phase voltage.
- ◆ To prevent damage to your installation it is important that all devices are properly grounded.
- ◆ The device is equipped with a 3-wire grounding type plug. This is a safety feature. If you are unable to insert the plug into the outlet, contact your electrician to replace your obsolete outlet. Do not attempt to defeat the purpose of the grounding-type plug. Always follow your local/national wiring codes.
- ◆ Do not allow anything to rest on the power cord or cables. Route the power cord and cables so that they cannot be stepped on or tripped over.
- ◆ If an extension cord is used with this device make sure that the total of the ampere ratings of all products used on this cord does not exceed the

extension cord ampere rating. Make sure that the total of all products plugged into the wall outlet does not exceed 15 amperes.

- ◆ To help protect your system from sudden, transient increases and decreases in electrical power, use a surge suppressor, line conditioner, or uninterruptible power supply (UPS).
- ◆ Position system cables and power cables carefully; Be sure that nothing rests on any cables.
- ◆ Never push objects of any kind into or through cabinet slots. They may touch dangerous voltage points or short out parts resulting in a risk of fire or electrical shock.
- ◆ Do not attempt to service the device yourself. Refer all servicing to qualified service personnel.
- ◆ If the following conditions occur, unplug the device from the wall outlet and bring it to qualified service personnel for repair.
 - ◆ The power cord or plug has become damaged or frayed.
 - ◆ Liquid has been spilled into the device.
 - ◆ The device has been exposed to rain or water.
 - ◆ The device has been dropped, or the cabinet has been damaged.
 - ◆ The device exhibits a distinct change in performance, indicating a need for service.
 - ◆ The device does not operate normally when the operating instructions are followed.
- ◆ Only adjust those controls that are covered in the operating instructions. Improper adjustment of other controls may result in damage that will require extensive work by a qualified technician to repair.

Technical Support

International

- ◆ For online technical support – including troubleshooting, documentation, and software updates: <http://support.aten.com>
- ◆ For telephone support, see *Telephone Support*, page iii:

North America

Email Support		support@aten-usa.com
Online Technical Support	Troubleshooting Documentation Software Updates	http://www.aten-usa.com/support
Telephone Support		1-888-999-ATEN ext 4988 1-949-428-1111

When you contact us, please have the following information ready beforehand:

- ◆ Product model number, serial number, and date of purchase
- ◆ Your computer configuration, including operating system, revision level, expansion cards, and software
- ◆ Any error messages displayed at the time the error occurred
- ◆ The sequence of operations that led up to the error
- ◆ Any other information you feel may be of help

Specifications

Function	VE2812AUST	VE2812AEUT
Video Input		
Interfaces	1 x HDMI Type A Female (Black) 1 x HDB-15 (VGA) Female (Blue)	
Impedance	HDMI: 100 Ω HDB-15 (VGA): 75 Ω	
Max. Distance	1.8 m	
Video		
Max. Data Rate	10.2 Gbps (3.4 Gbps per lane)	
Max. Pixel Clock	340 MHz	
Compliance	HDMI (3D, Deep Color, 4K)	
	HDCP Compatible	
	Consumer Electronics Control (CEC)	
Max. Resolutions / Distances	HDMI: <ul style="list-style-type: none"> ◆ Up to 4k @70m (Cat 5e/6) / 100m (Cat 6a/ATEN 2L-2910 Cat6) ◆ Up to 1080p @100m (Cat 5e/6/6a) VGA: <ul style="list-style-type: none"> ◆ Up to 1920 x 1200 & 1600 x 1200 @70m (Cat 5e/6) / 100m (Cat 6a/ATEN 2L-s910 Cat 6) ◆ Up to 1920 x 1080 @100m (Cat 5e/6/6a) 4k supported: <ul style="list-style-type: none"> ◆ 4096 x 2160 / 3840 x 2160 @60Hz (4:2:0) ◆ 4096 x 2160 / 3840 x 2160 @30Hz (4:4:4) 	
Audio		
Input	1 x HDMI Type A Female (Black) 1 x Mini Stereo Jack Female (Black)	
Control		
RS-232	Connectors	1 x Terminal Block, 3 Pole (Green)
	Baud Rate	19200
	Data Bits	8
	Stop Bits	1, no parity and flow control
IR	1 x Mini Stereo Jack Female (Black)	

Function	VE2812AUST	VE2812AEUT
Switches		
Video Input Port Selection	1 x Pushbutton - HDMI, VGA, and AUTO	
Long Reach Mode Switch	1 Slide Switch - ON/OFF	
Firmware Upgrade	1 Slide Switch - ON/OFF	
Power		
Unit to Unit	1 x RJ-45 Female (PoH)	
Connectors	1 x Terminal Block, 2 Pole (Green)	
Consumption	DC 5V;3.04W;14BTU DC 48V;3.8W;18BTU	DC 5V;3.14W;15BTU DC 48V;3.92W;18BTU
Environmental		
Operating Temperature	0 - 40°C	
Storage Temperature	-20 - 60°C	
Humidity	0 x 80% RH, Non-Condensing	
Physical Properties		
Housing	Metal	
Weight	0.21kg (0.46 lb)	0.30kg (0.66 lb)
Dimensions (L x W x H)	10.42 x 8.79 x 5.19 cm ³ (4.10 x 3.46 x 2.04 in. ³)	5.00 x 10.80 x 5.17 cm ³ (1.97 x 4.25 x 2.04 in. ³)
Dimensions (L x W x H)	11.43 x 11.43 x 0.60 cm ³ (4.5 x 4.5 x 0.24 in. ³)	8.60 x 15.10 x 1.35 cm ³ (3.39 x 5.94 x 0.53 in. ³)

Supported VGA Resolutions

The VE2812AUST / VE2812AEUT supports the following VGA resolutions:

VGA Resolution	Frame Rate (Hz)
640 x 480	60
640 x 480	75
800 x 600	60
800 x 600	75
1024 x 768	60
1024 x 768	75
1152 x 564	60
1152 x 564	75
1280 x 600	60
1280 x 720	60
1280 x 768	60
1280 x 800	60
1280 x 800	75
1280 x 960	60
1280 x 1024	60
1280 x 1024	75
1360 x 768	60
1366 x 768	60
1400 x 1050	60
1440 x 900	60
1600 x 900	60
1600 x 1200	60
1680 x 1050	60
1920 x 1080	60

Limited Warranty

ATEN warrants its hardware in the country of purchase against flaws in materials and workmanship for a Warranty Period of two [2] years (warranty period may vary in certain regions/countries) commencing on the date of original purchase. This warranty period includes the LCD panel of ATEN LCD KVM switches. Select products are warranted for an additional year (see *A+ Warranty* for further details). Cables and accessories are not covered by the Standard Warranty.

What is covered by the Limited Hardware Warranty

ATEN will provide a repair service, without charge, during the Warranty Period. If a product is defective, ATEN will, at its discretion, have the option to (1) repair said product with new or repaired components, or (2) replace the entire product with an identical product or with a similar product which fulfills the same function as the defective product. Replaced products assume the warranty of the original product for the remaining period or a period of 90 days, whichever is longer. When the products or components are replaced, the replacing articles shall become customer property and the replaced articles shall become the property of ATEN.

To learn more about our warranty policies, please visit our website:
<http://www.aten.com/global/en/legal/policies/warranty-policy>

Template Printing

Please use 1:1 ratios when printing.

We also recommend using A4 sized paper or larger.

After printing, please measure the print so that the labeled measurement is correct.

VE2812AUST Screw Sites Template

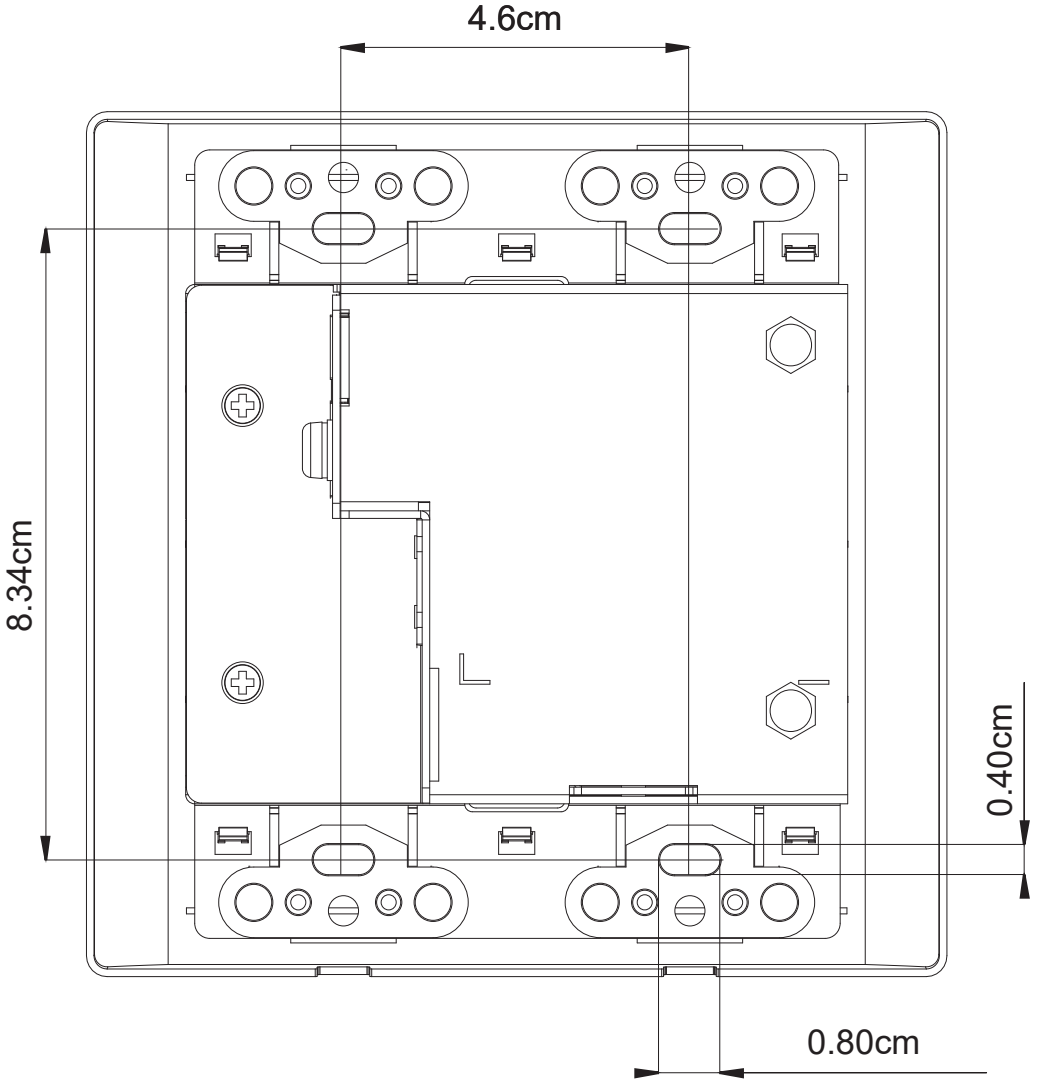

VE2812AEUT Screw Sites Template

